

Op de tast...
het metrieke stelsel

Op de tast...

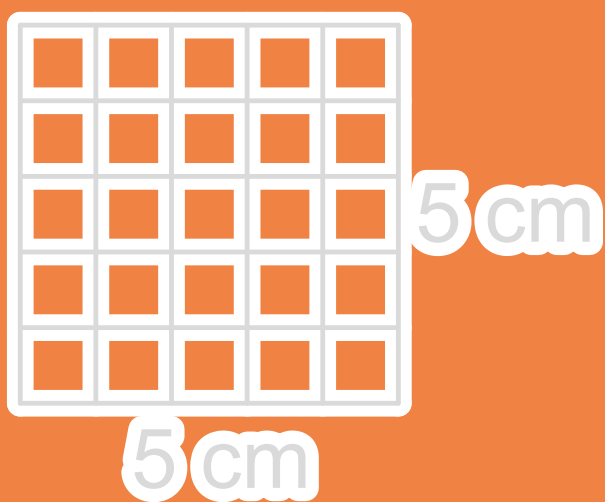

het metrieke stelsel

Bij deze tekeningenband
hoort gelijknamige uitleg
in braille of Edu-tekst















Dedicon, 2020 versie 01

334421_1

Dit is een inzage-exemplaar. Kopiëren en vermenigvuldigen is niet toegestaan.
Deze tekening komt uit een Op de Tast boek, uitsluitend te bestellen door of
voor leerlingen met een visuele beperking op <https://educatief.dedicon.nl>

© dedicon

1. Lengtematen

 1 km	=	 1.000 m
 1 hm	=	 100 m
 1 dam	=	 10 m
 1 m	=	 1 m
 1 dm	=	 0,1 m
 1 cm	=	 0,01 m
 1 mm	=	 0,001 m

2. Omrekenen van lengtematen

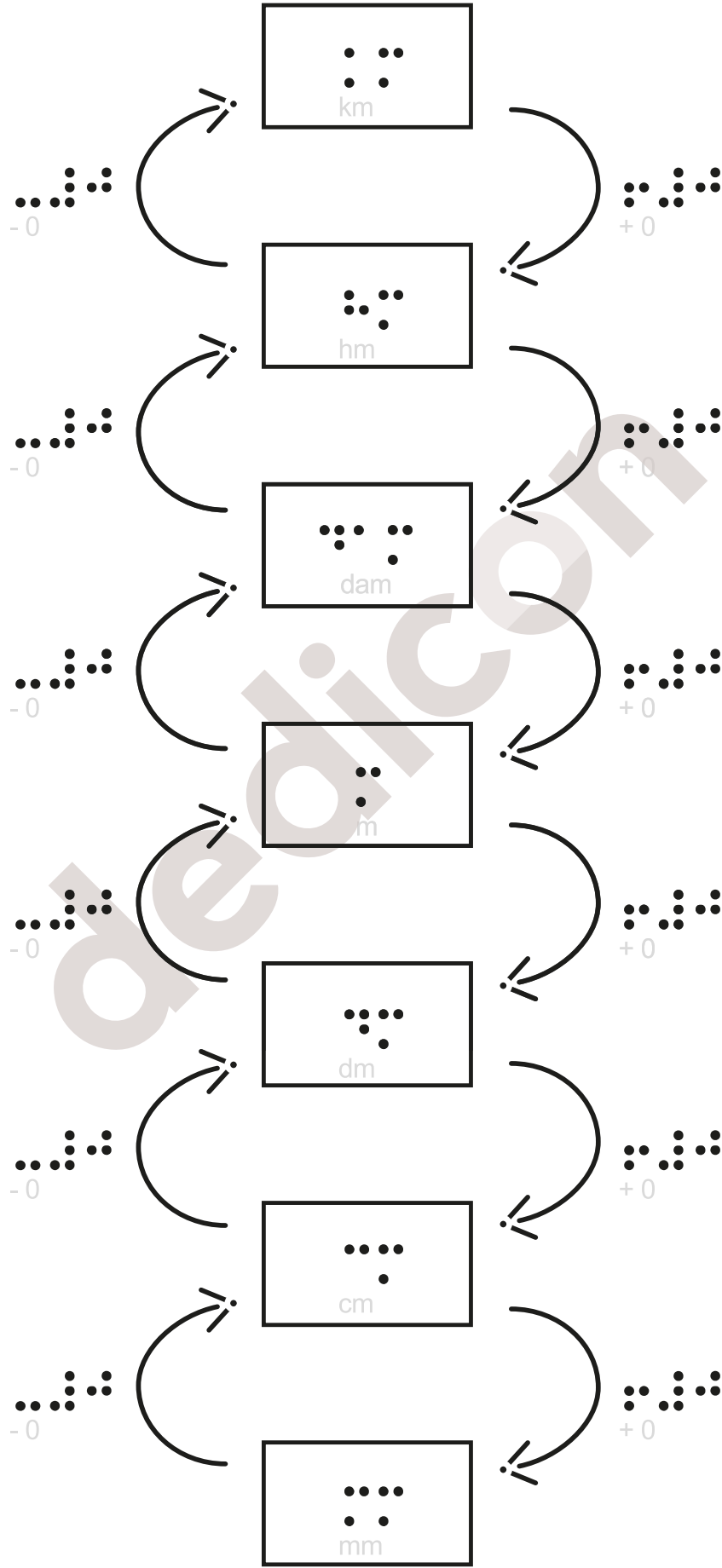

3. Oppervlakte

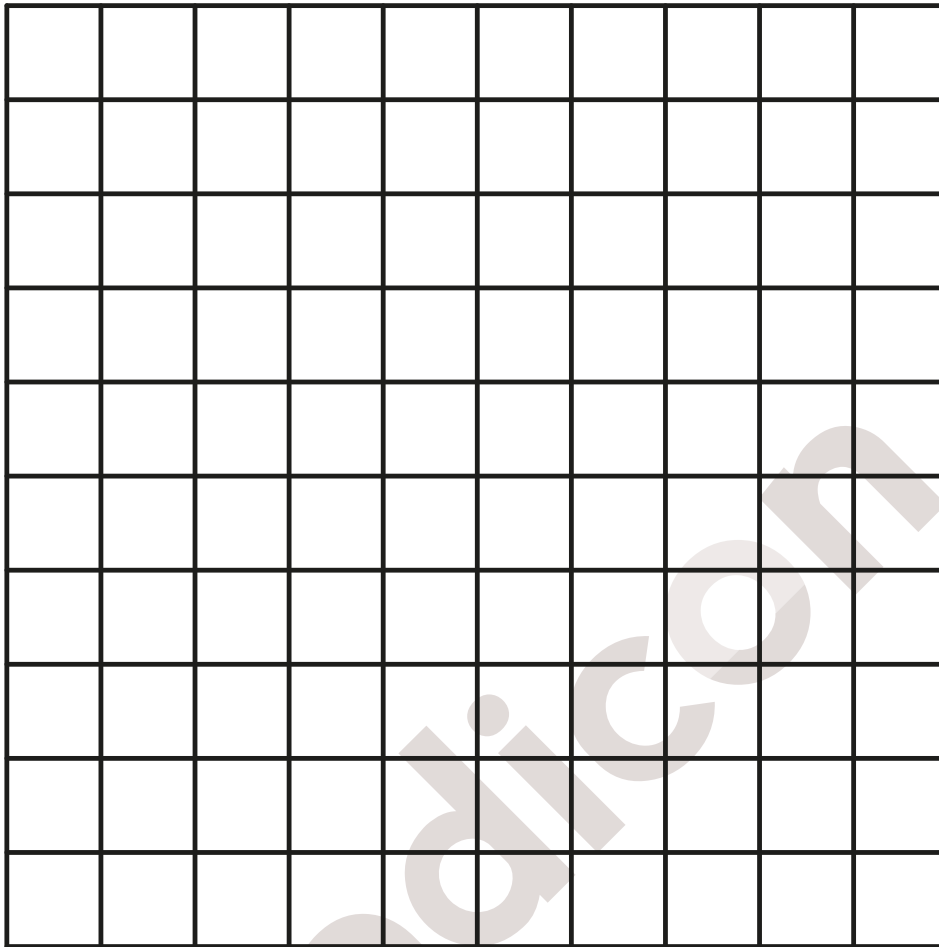

10 dm

10 dm

4. Oppervlaktematen

1 km^2	=	$1.000.000 \text{ m}^2$
1 hm^2	=	10.000 m^2
1 dam^2	=	100 m^2
1 m^2	=	1 m^2
1 dm^2	=	$0,01 \text{ m}^2$
1 cm^2	=	$0,000.1 \text{ m}^2$
1 mm^2	=	$0,000.001 \text{ m}^2$

5. Omrekenen van oppervlaktematen

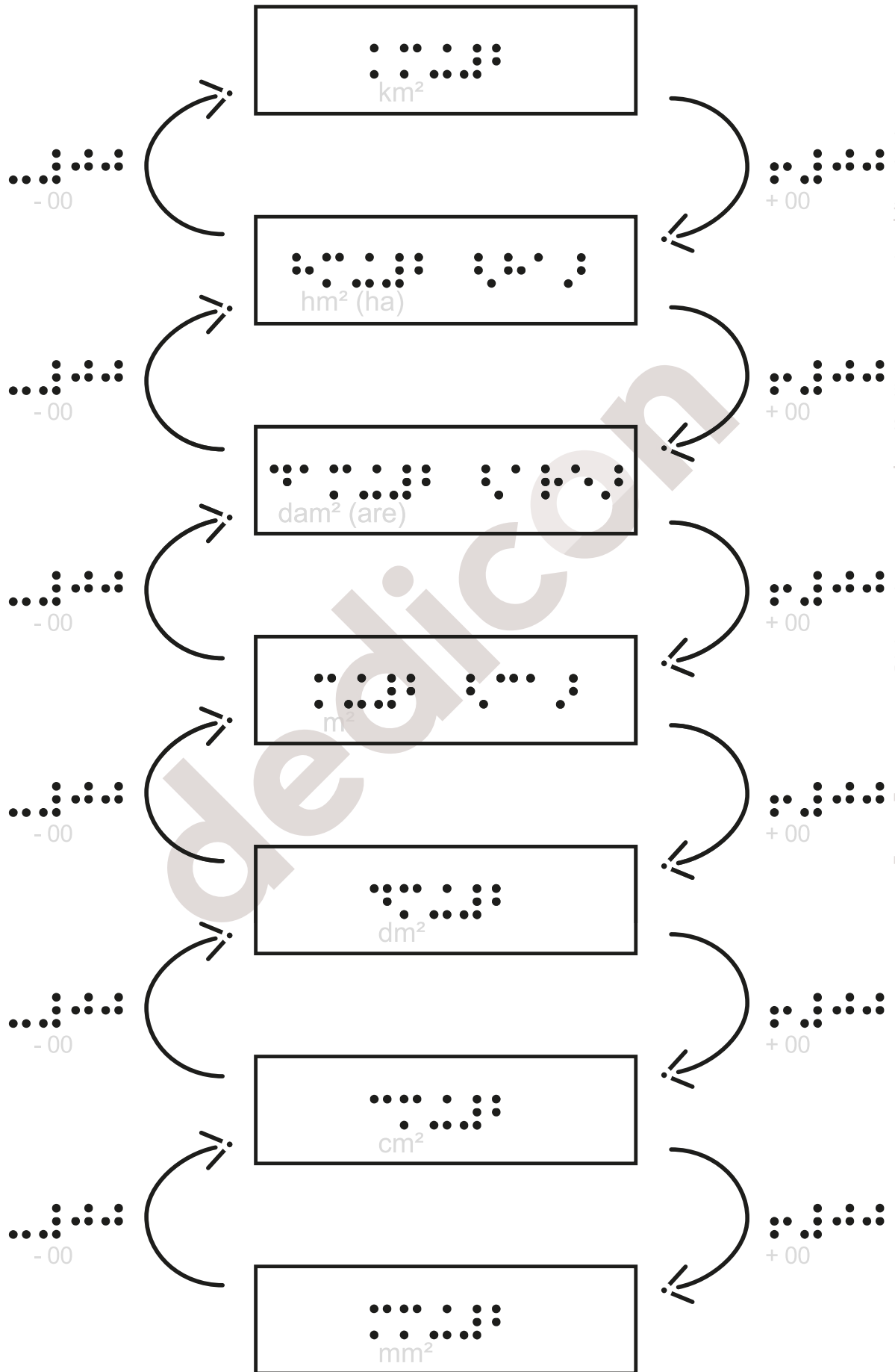

Dit is een inzage-exemplaar. Kopiëren en vermenigvuldigen is niet toegestaan. Deze tekening komt uit een Op de Tast boek, uitsluitend te bestellen door of voor leerlingen met een visuele beperking op <https://educatief.dedicon.nl>

6. Inhoudsmaten





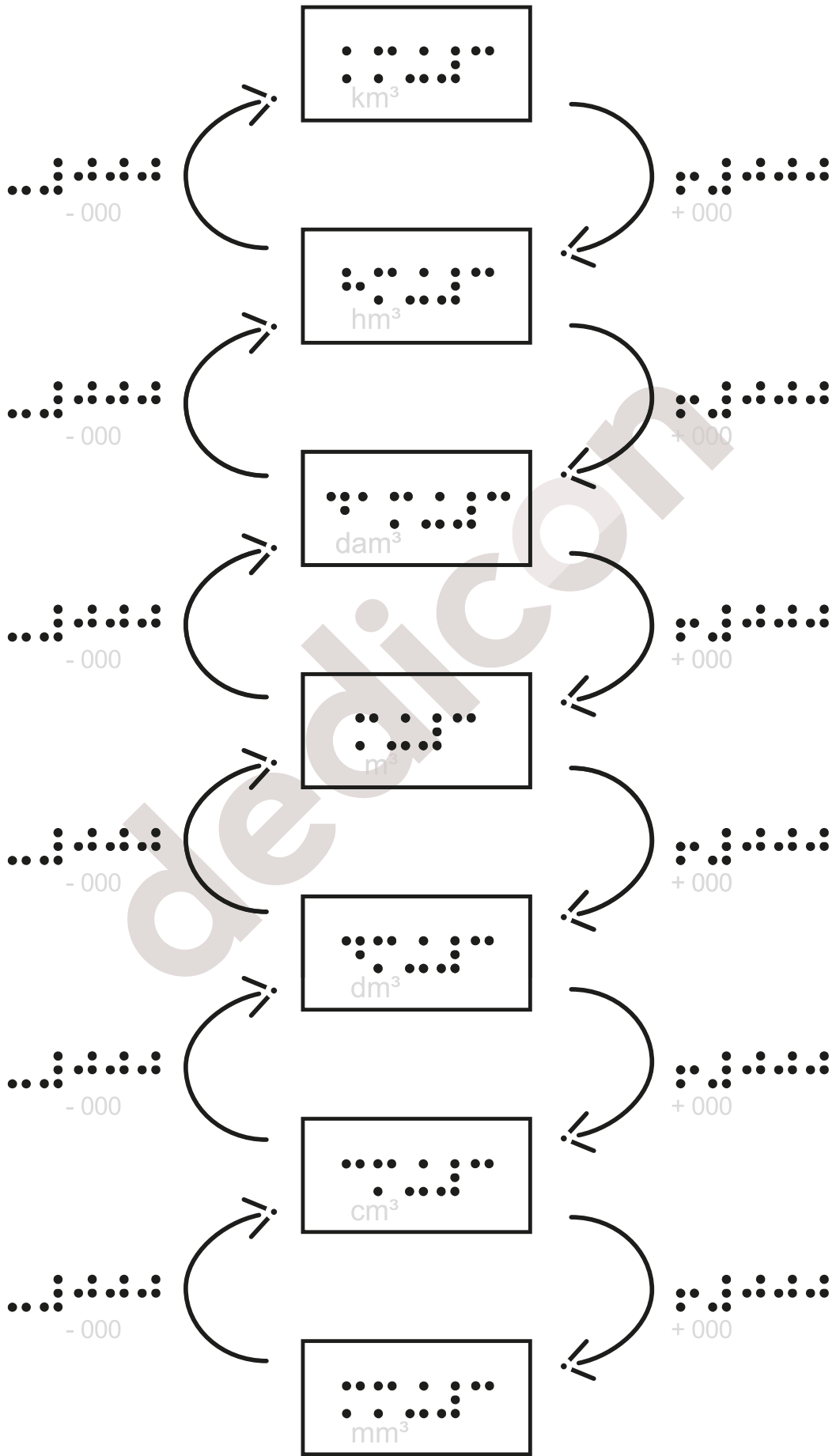









1 km^3	=	$1.000.000.000 \text{ m}^3$
1 hm^3	=	$1.000.000 \text{ m}^3$
1 dam^3	=	1.000 m^3
1 m^3	=	1 m^3
1 dm^3	=	$0,001 \text{ m}^3$
1 cm^3	=	$0,000.001 \text{ m}^3$
1 mm^3	=	$0,000.000.001 \text{ m}^3$

7. Omrekenen van inhoudsmaten



Dit is een inzage-exemplaar. Kopiëren en vermenigvuldigen is niet toegestaan. Deze tekening komt uit een Op de Tast boek, uitsluitend te bestellen door of voor leerlingen met een visuele beperking op <https://educatief.dedicon.nl>

8. Inhoud in liters





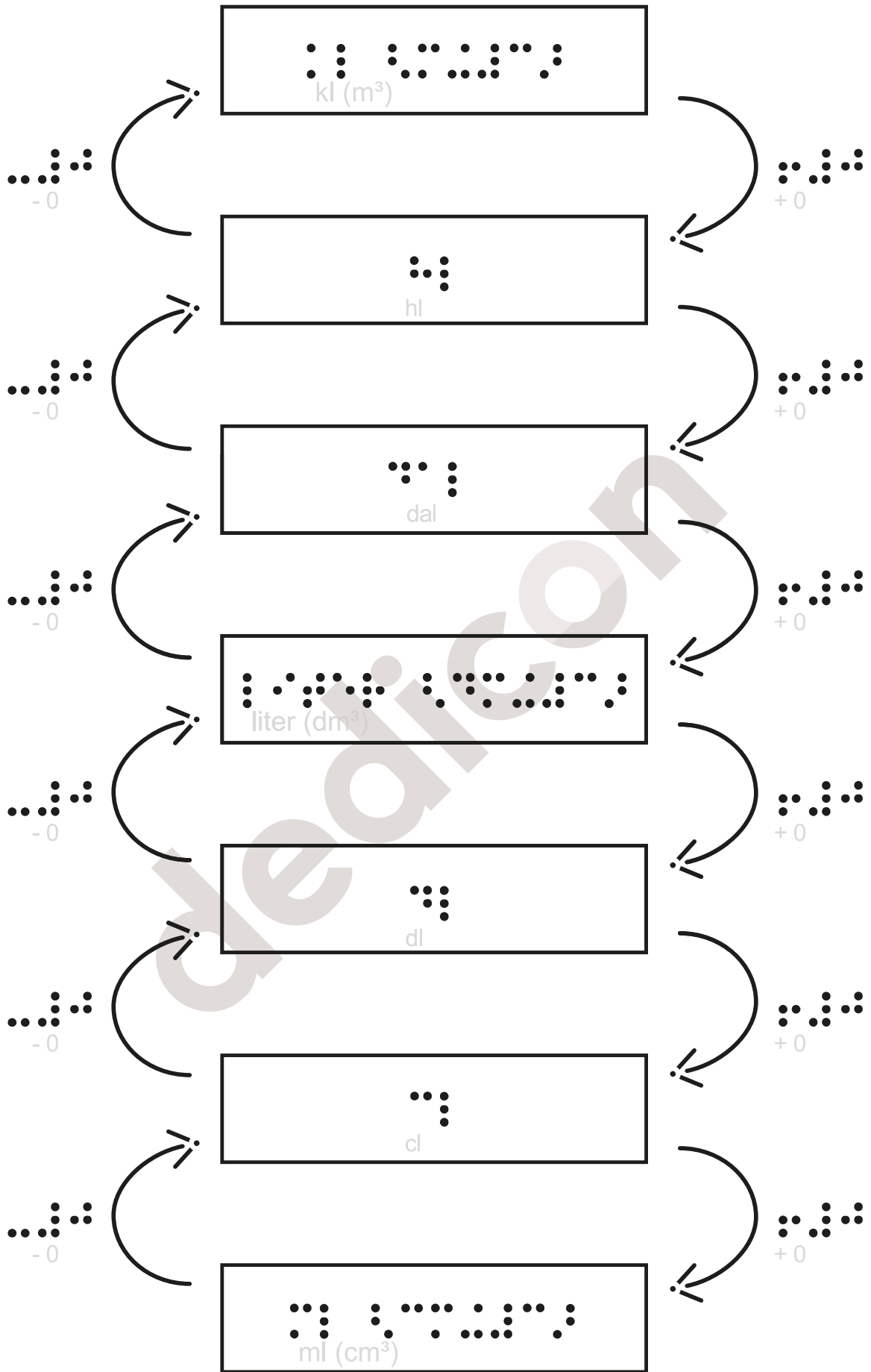









 1 kl	=	 1.000 l
 1 hl	=	 100 l
 1 dal	=	 10 l
 1 l	=	 1 l
 1 dl	=	 0,1 l
 1 cl	=	 0,01 l
 1 ml	=	 0,001 l

9. Omrekenen van inhoud in liters



Dit is een inzage-exemplaar. Kopiëren en vermenigvuldigen is niet toegestaan. Deze tekening komt uit een Op de Tast boek, uitsluitend te bestellen door of voor leerlingen met een visuele beperking op <https://educatief.dedicon.nl>

10. Maten van gewicht

 1 kg	=	 1.000 g
 1 hg	=	 100 g
 1 dag	=	 10 g
 1 g	=	 1 g
 1 dg	=	 0,1 g
 1 cg	=	 0,01 g
 1 mg	=	 0,001 g

11. Omrekenen maten van gewicht

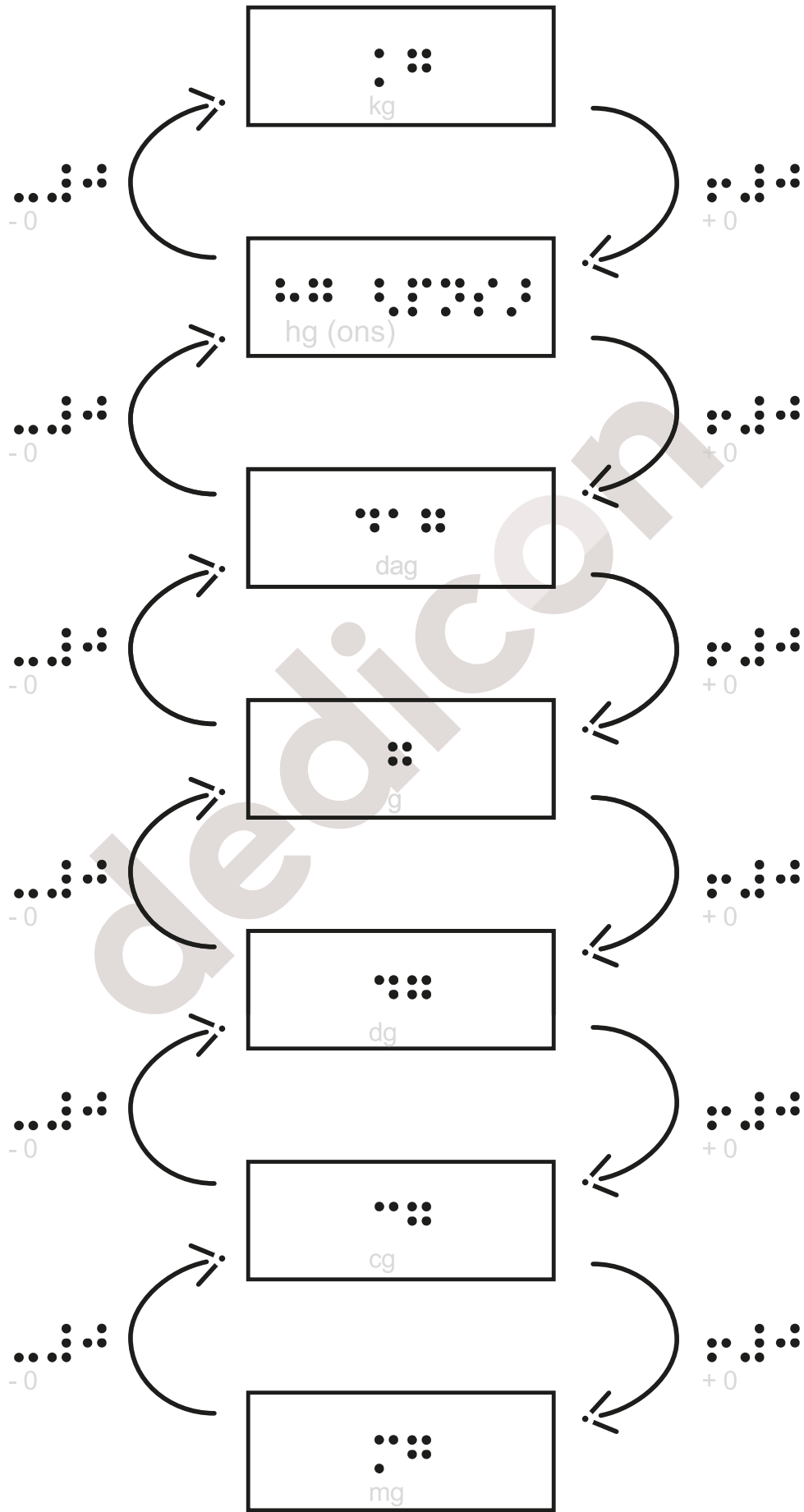

Dit is een inzage-exemplaar. Kopiëren en vermenigvuldigen is niet toegestaan.
Deze tekening komt uit een Op de Tast boek, uitsluitend te bestellen door of
voor leerlingen met een visuele beperking op <https://educatief.dedicon.nl>



12. Tabel met alle eenheden

	m	m^2	m^3	l	g
kilo	km	km^2	km^3	kl	kg
hecto	hm	hm^2	hm^3	hl	hg
deca	dam	dam^2	dam^3	dal	dag
...	m	m^2	m^3	l	g
deci	dm	dm^2	dm^3	dl	dg
centi	cm	cm^2	cm^3	cl	cg
milli	mm	mm^2	mm^3	ml	mg