



Bij deze tekeningenband
hoort gelijknamige uitleg
in braille of Edu-tekst



1. Budgetlijn (blad 1)

1.

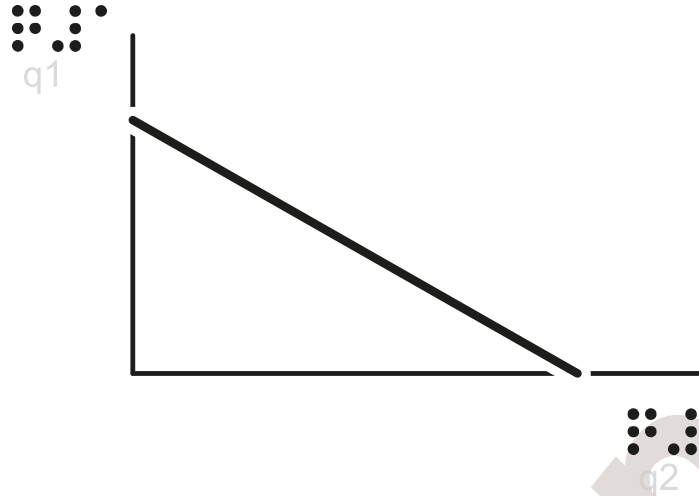

2.

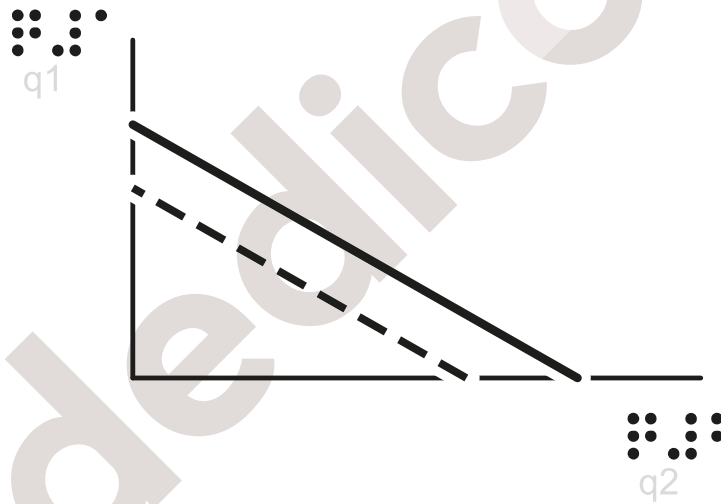

3.

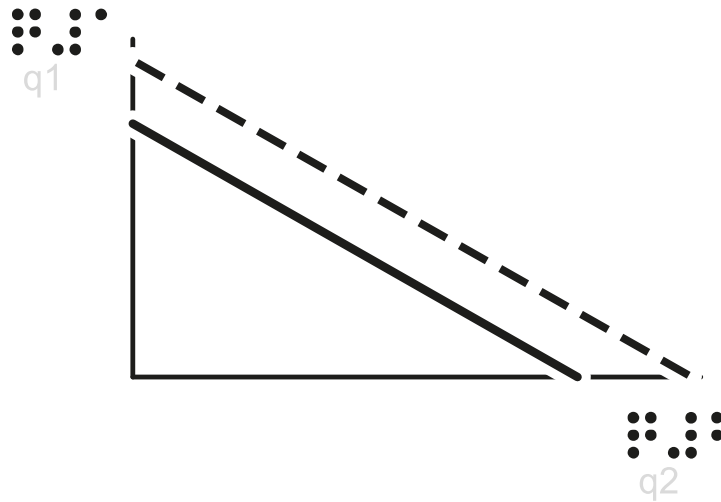



1. Budgetlijn (blad 2)

4.

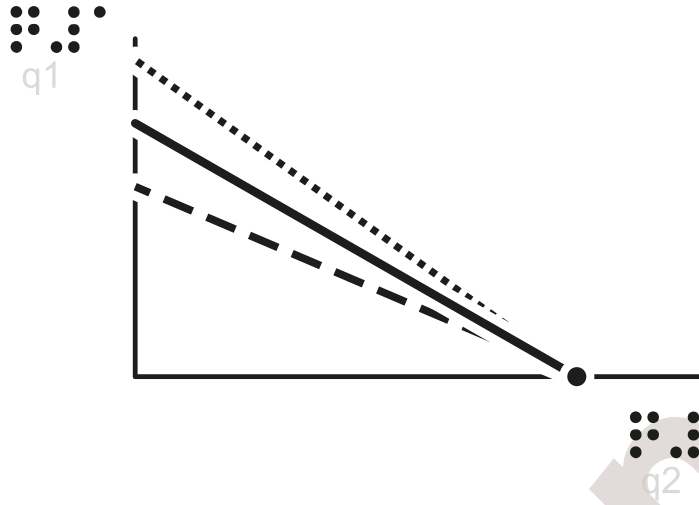

5.

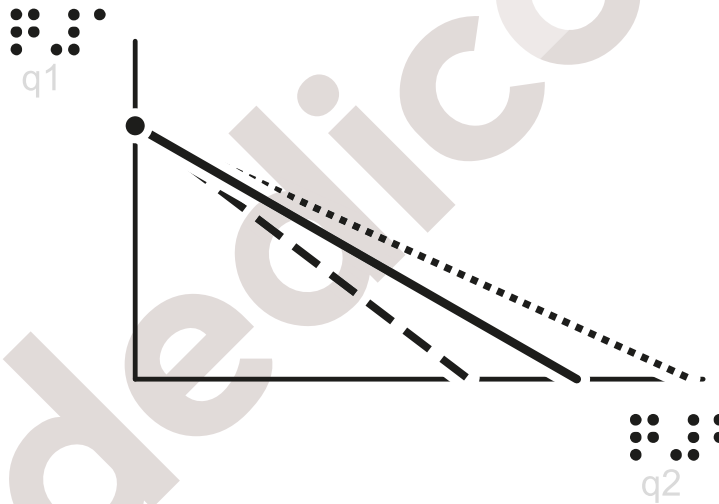

1.

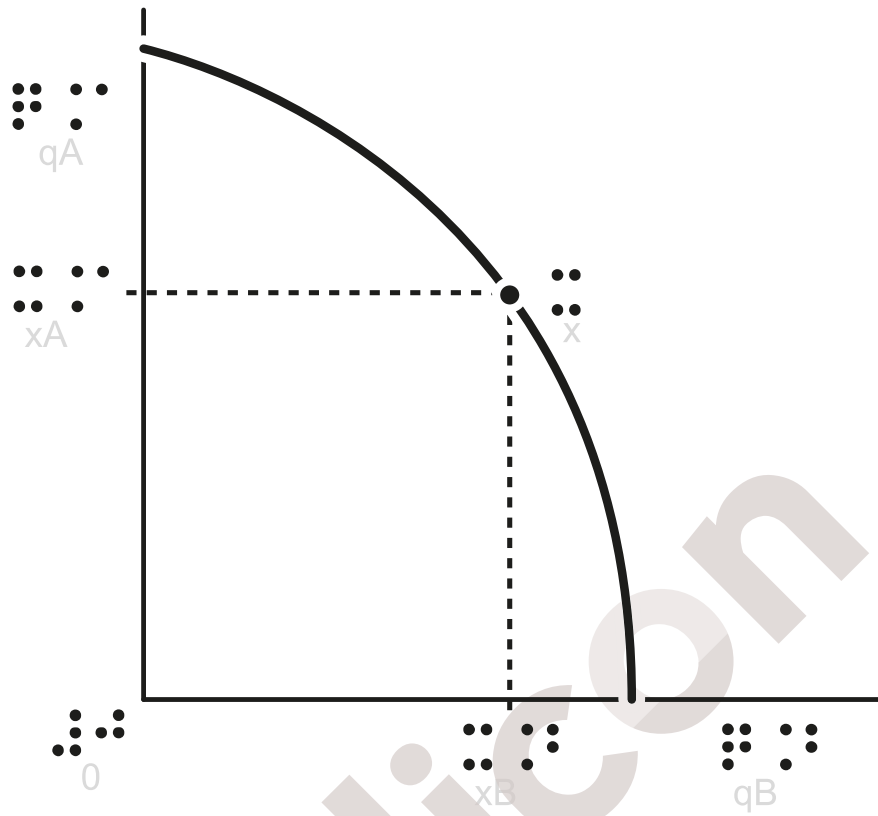

2.

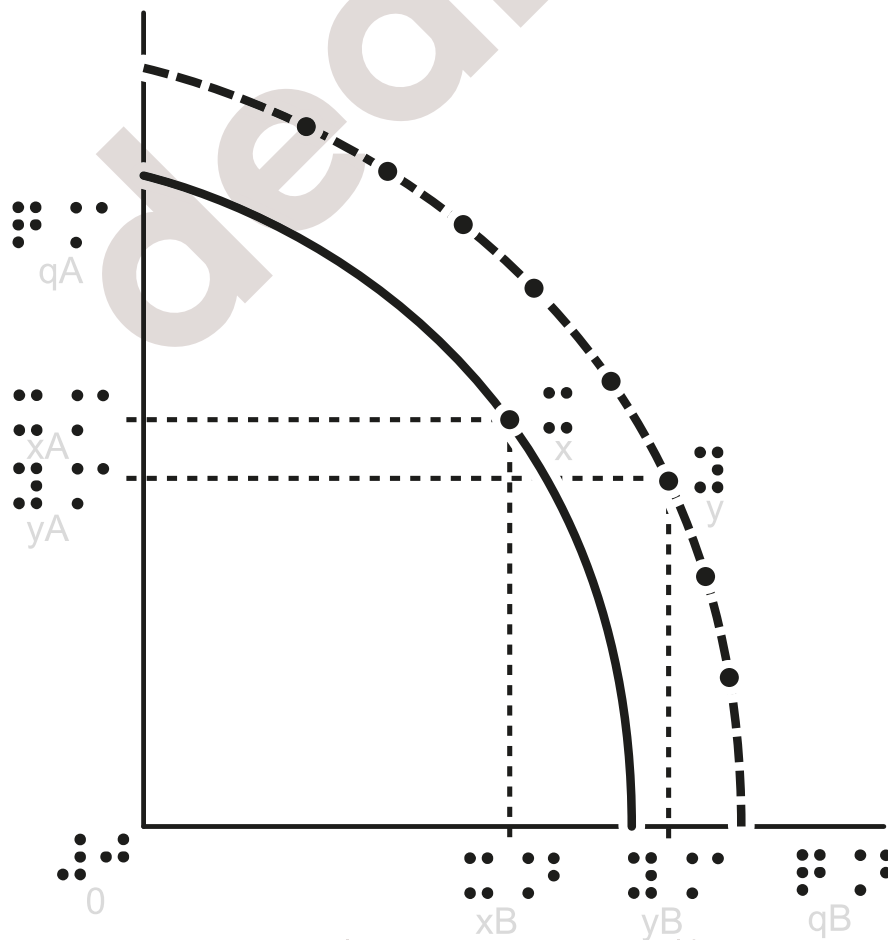

3.

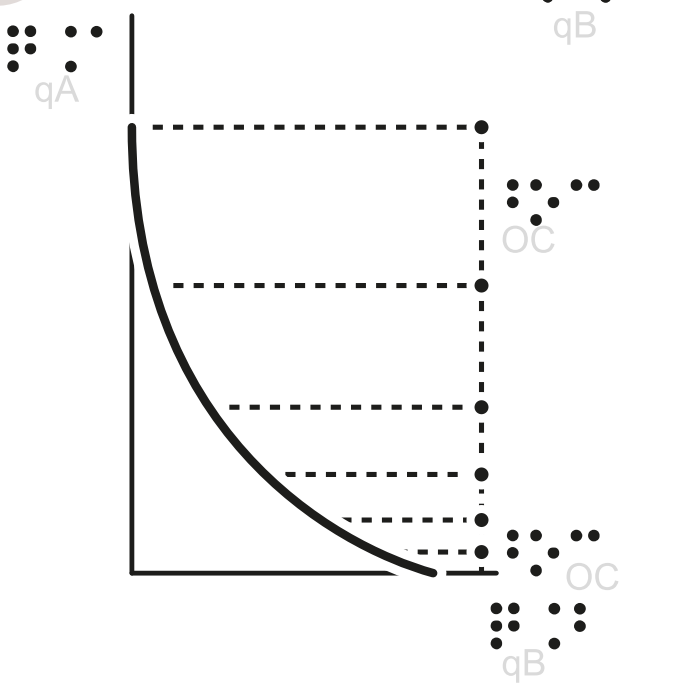
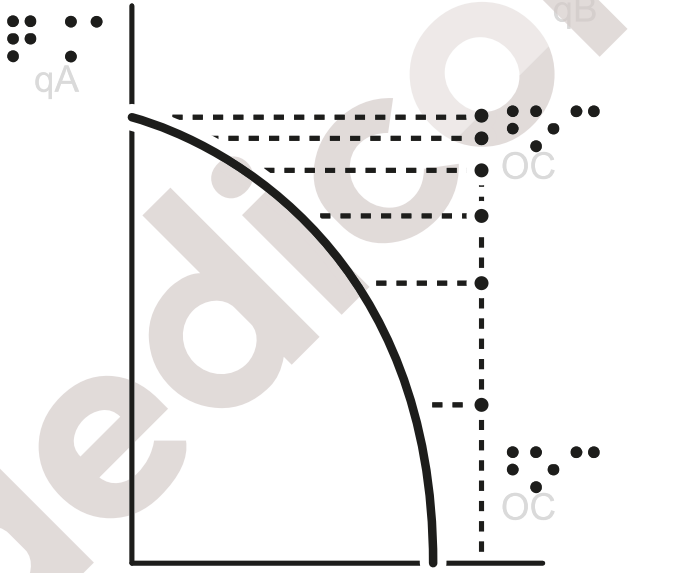
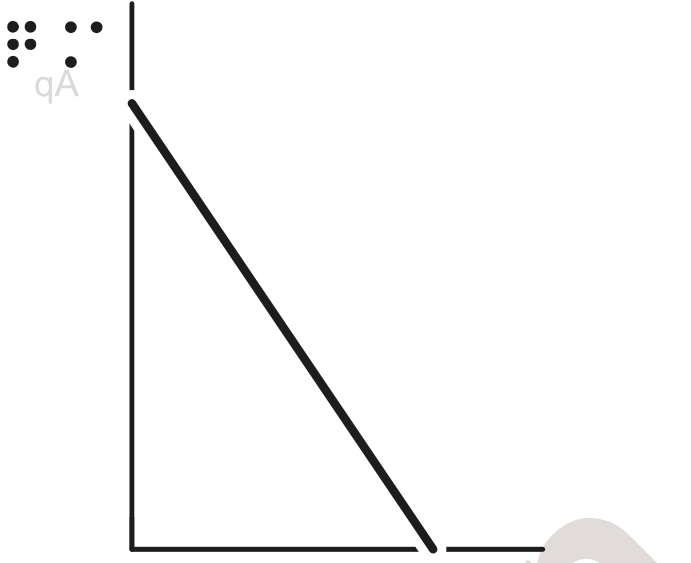

3. Vraaglijn
1.

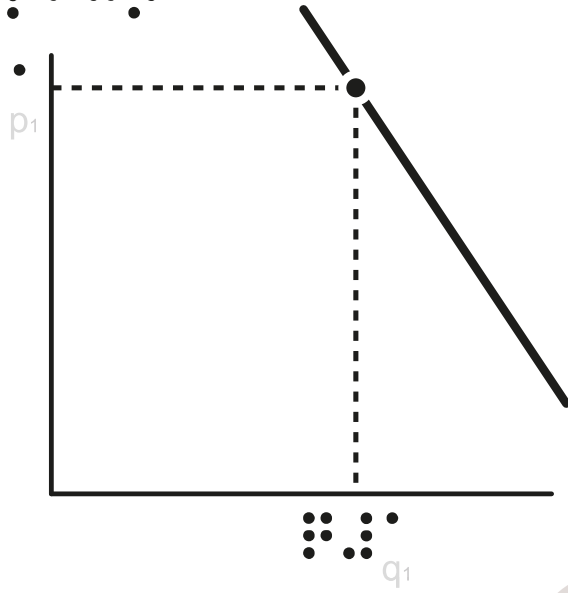

2.

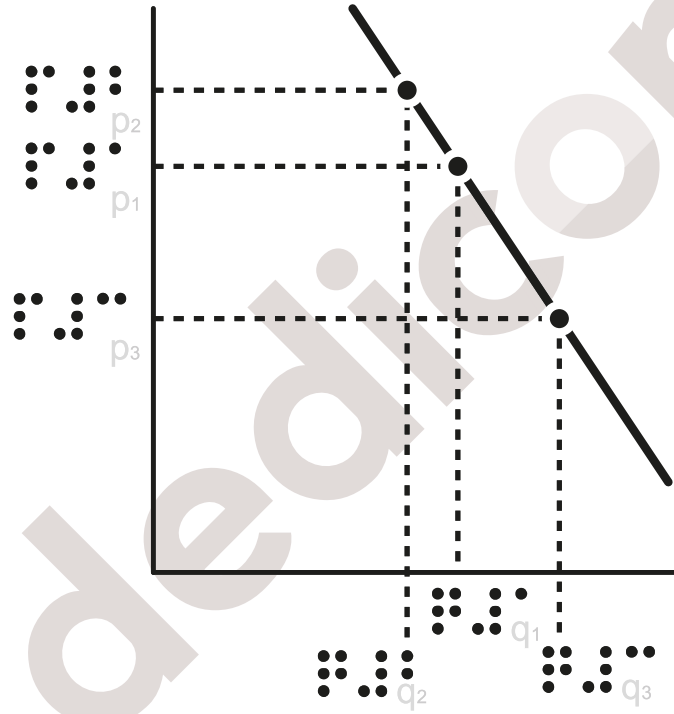

3.

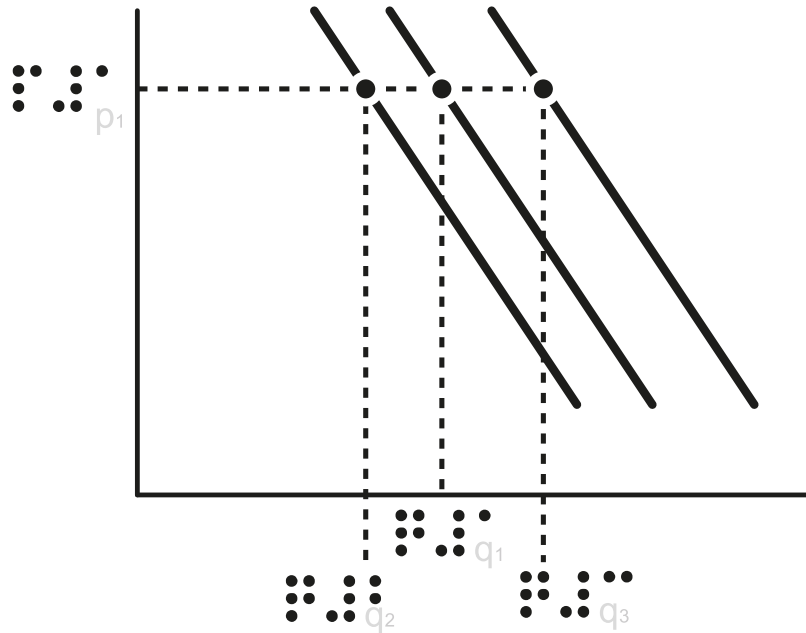

4. Aanbodlijn (blad 1)

1.

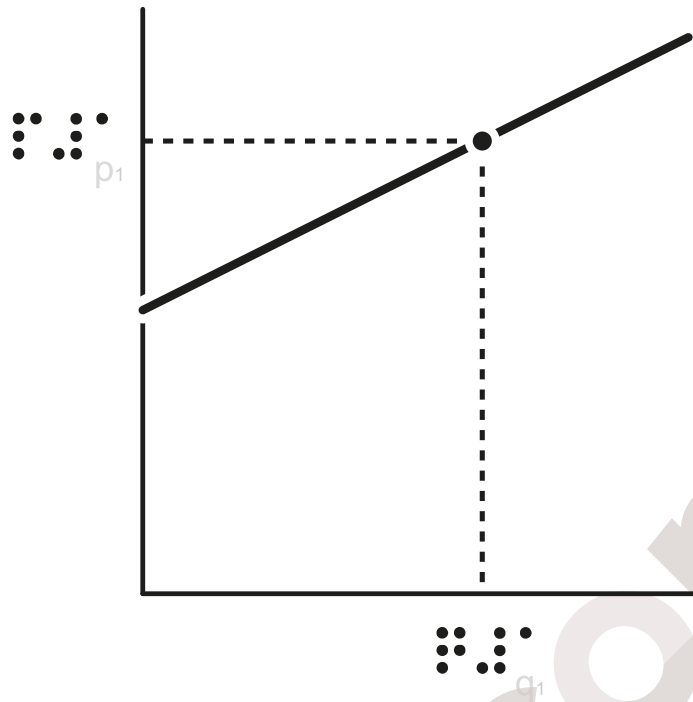

2.

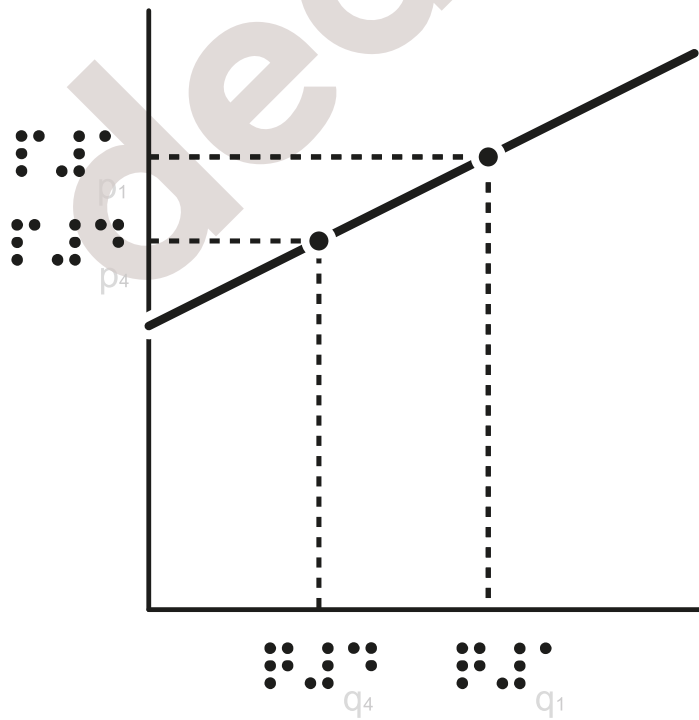

4. Aanbodlijn (blad 2)

3.

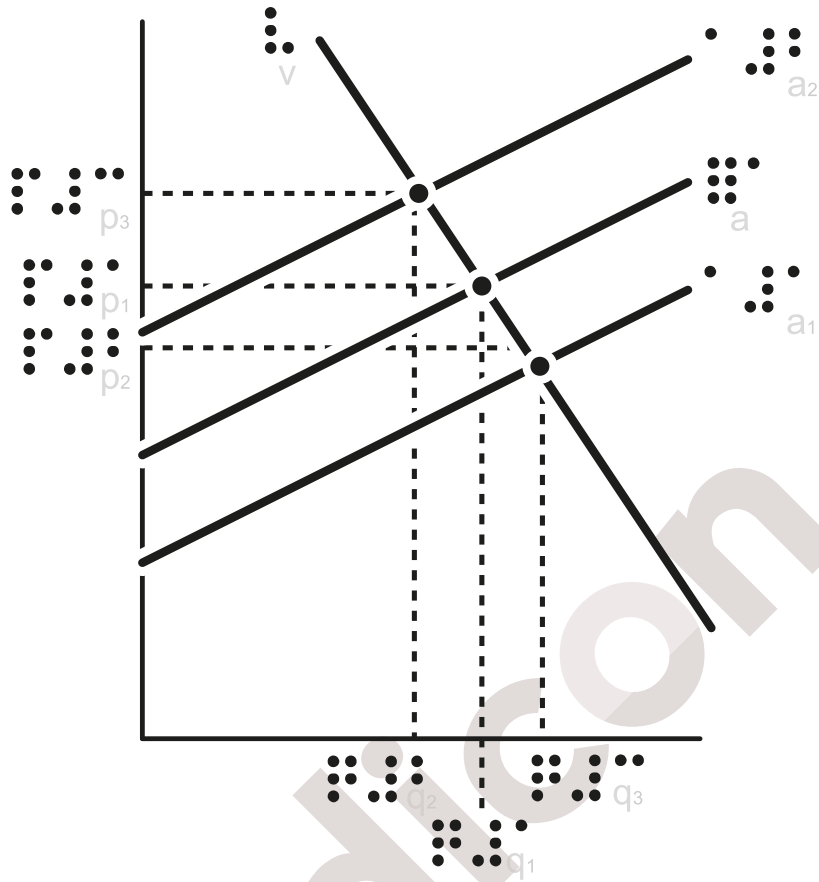

4.

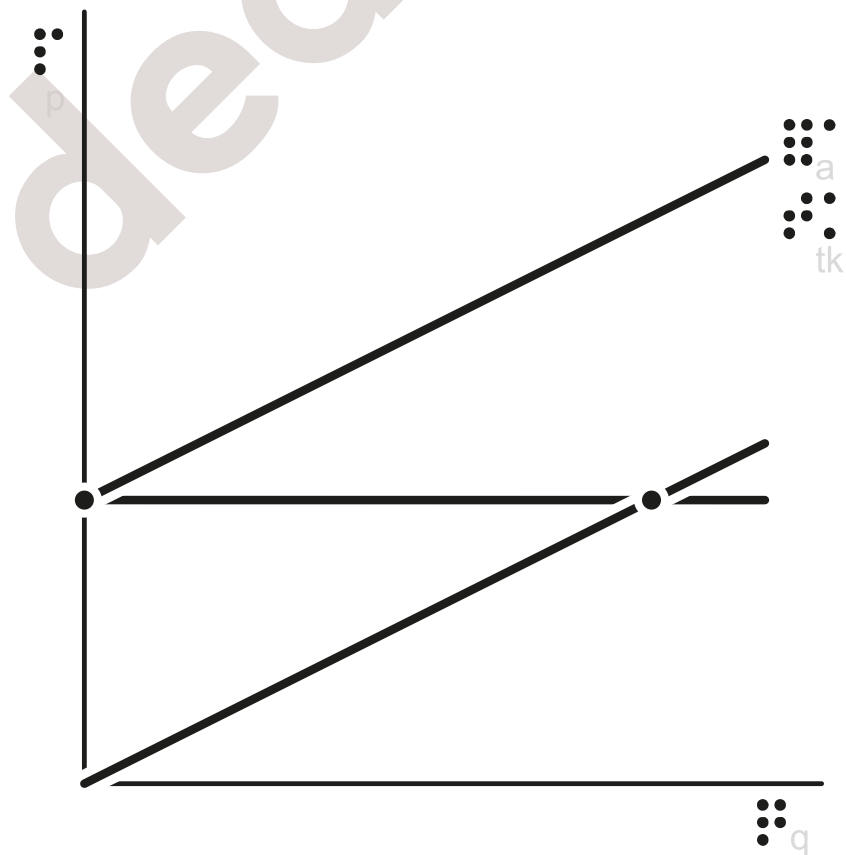

5. Kosten (blad 1)

1.a

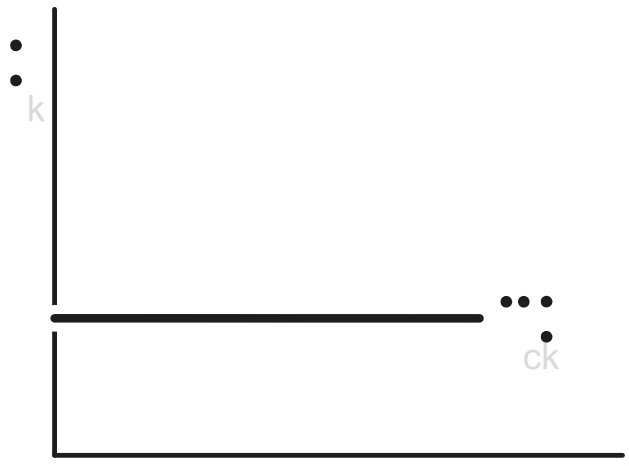

1.b

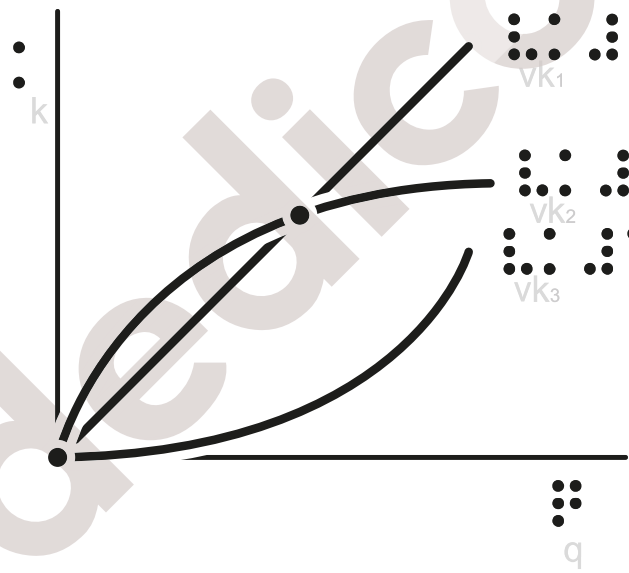

2.

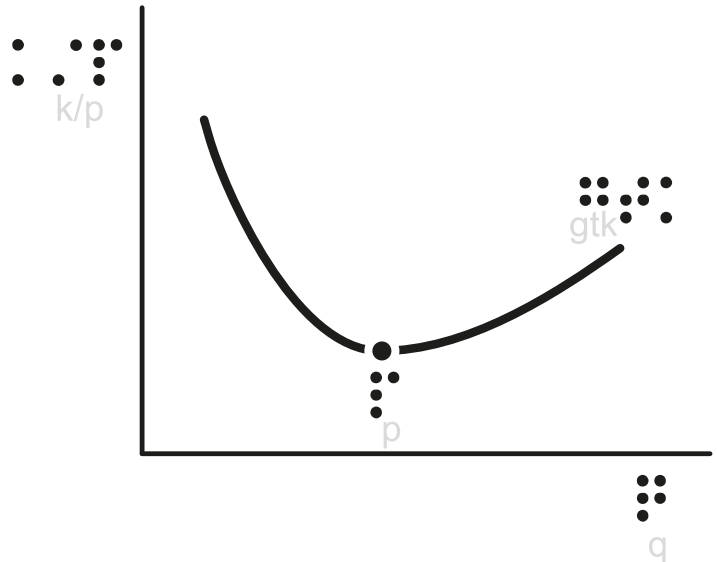

Dit is een inzage-exemplaar. Kopiëren en vermenigvuldigen is niet toegestaan. Deze tekening komt uit een Op de Tast boek, uitsluitend te bestellen door of voor leerlingen met een visuele beperking op <https://educatief.dedicon.nl>

5. Kosten (blad 2)
3.

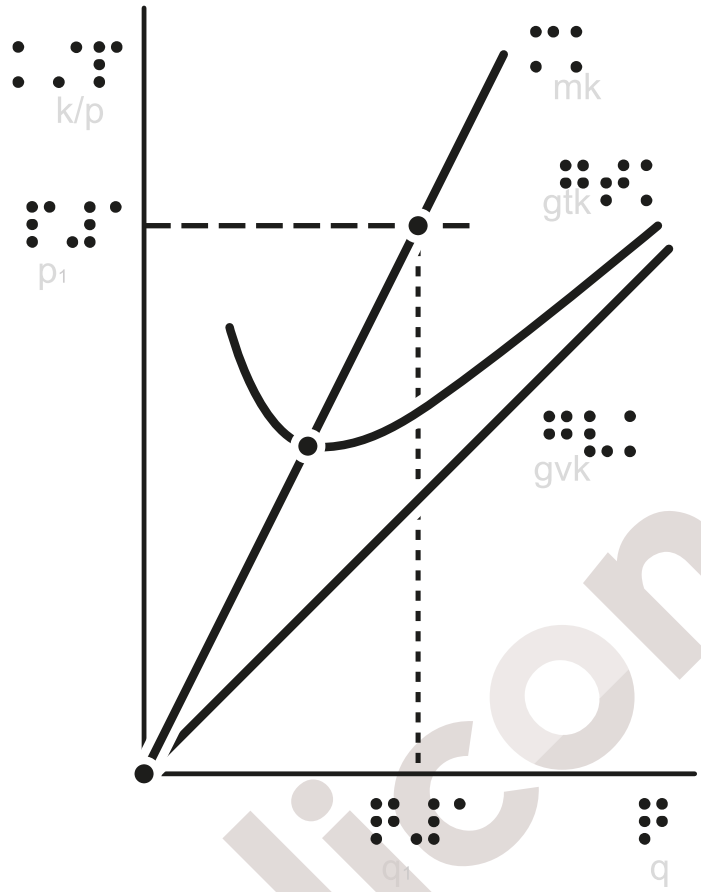

6. Economische groei

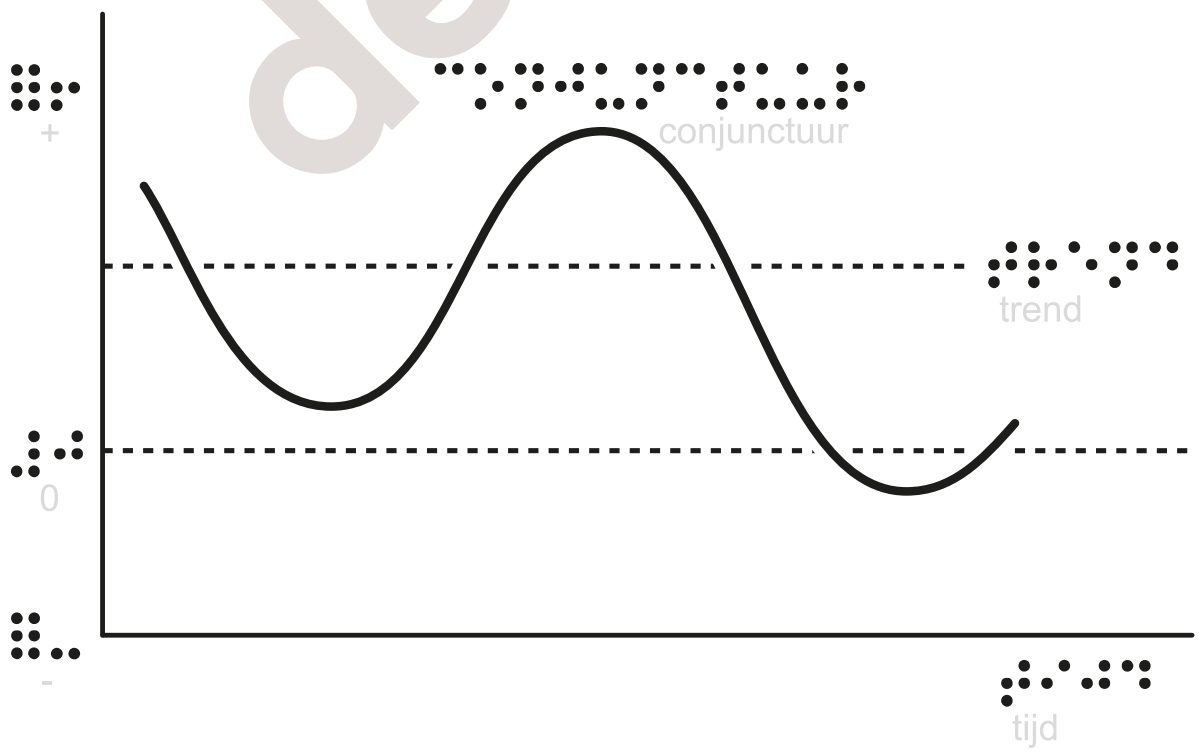

7. Welvaartseffecten: consumentensurplus

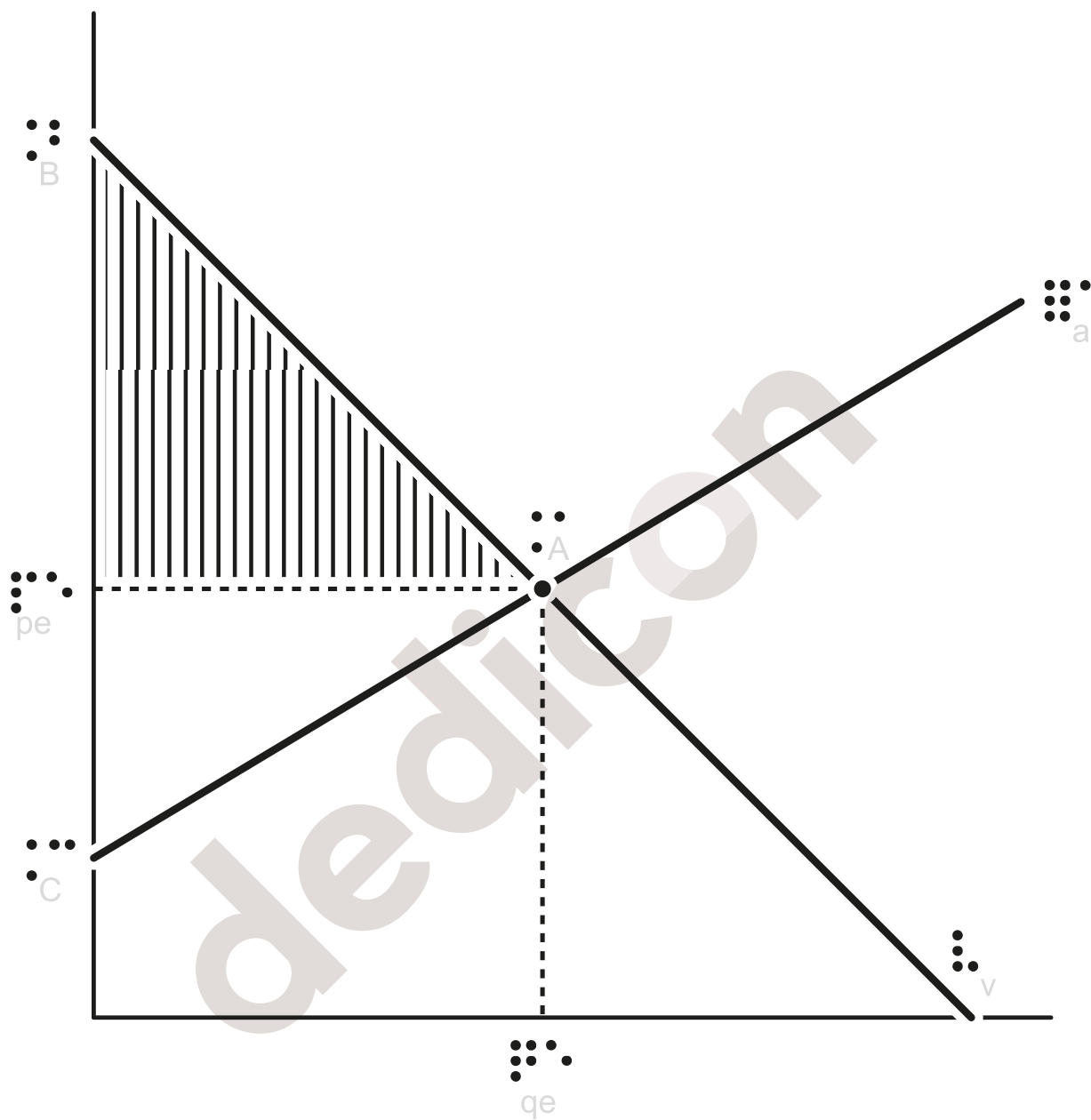

8. Welvaartseffecten: producentensurplus

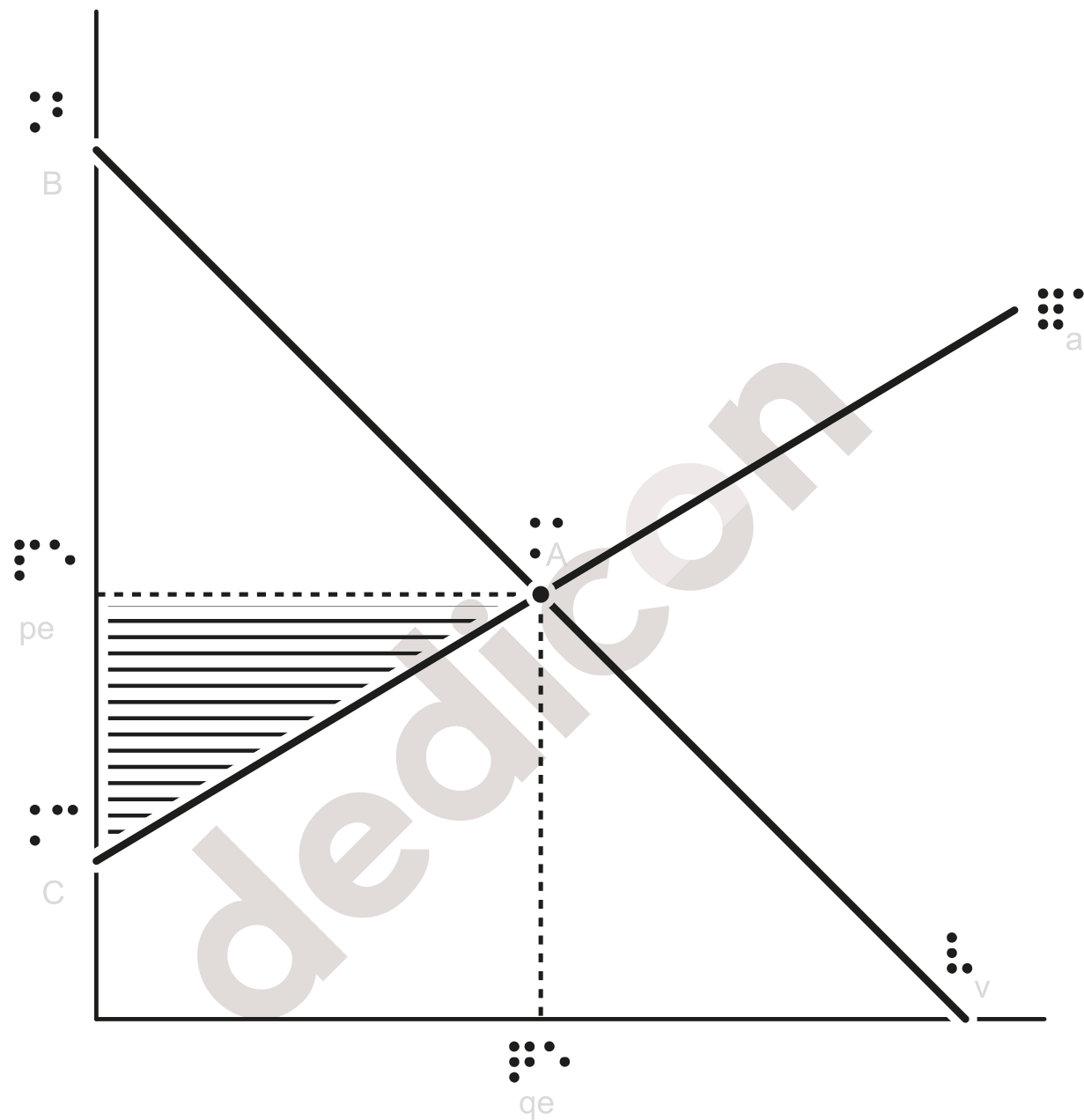

9. Welvaartseffecten: totale surplus

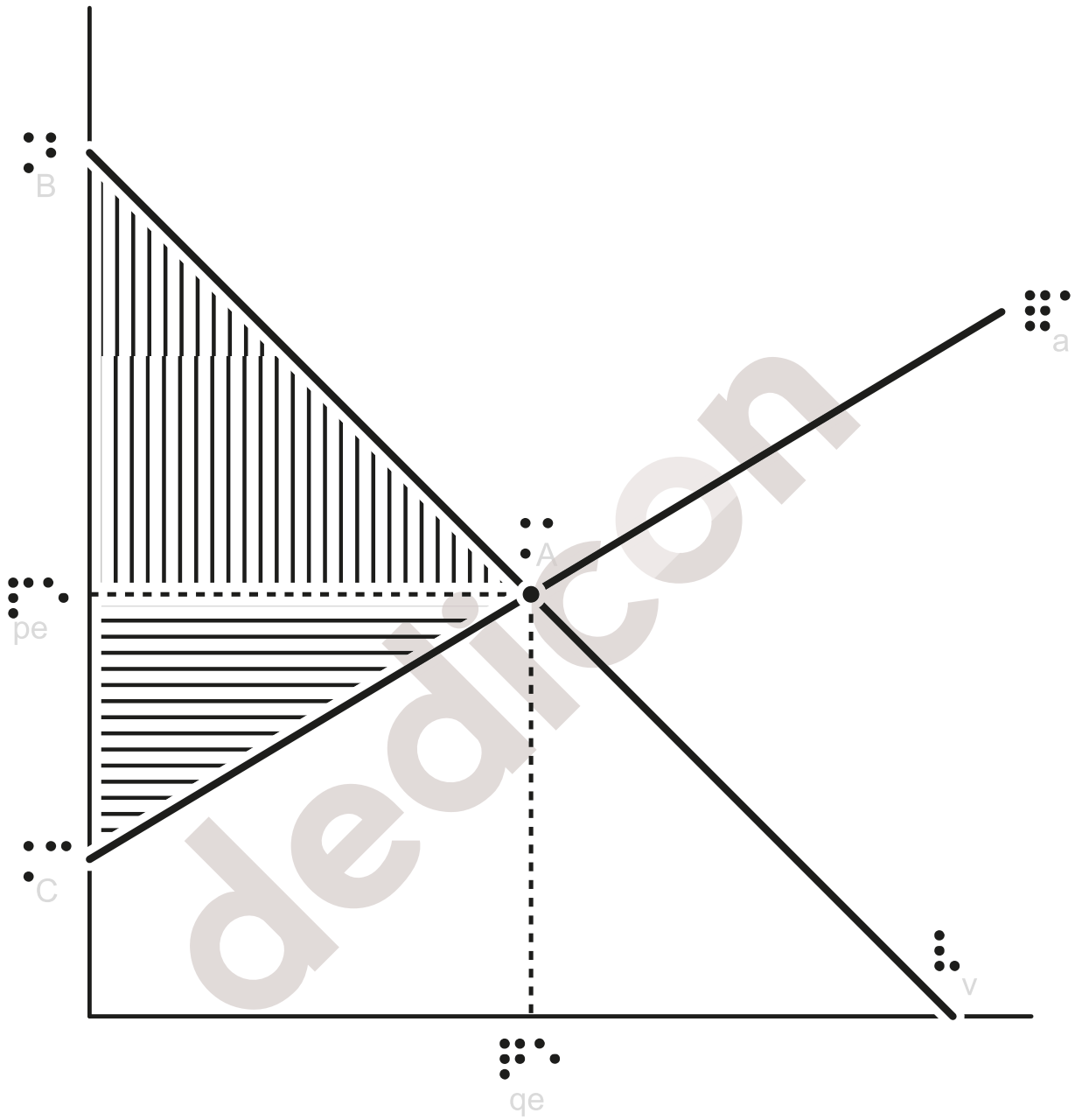

1.

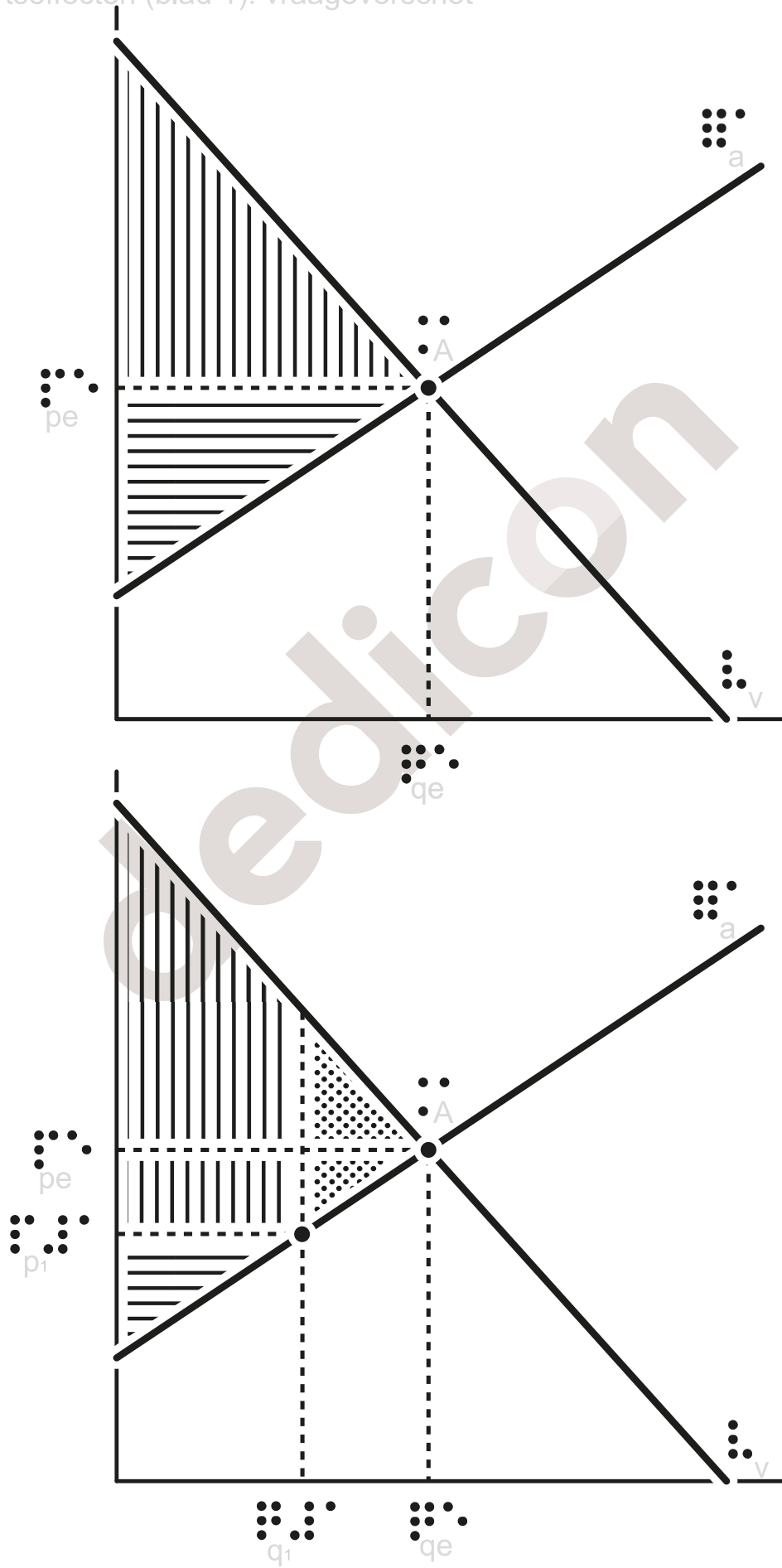



10. Welvaartseffecten (blad 2): aanbodoverschot

2.

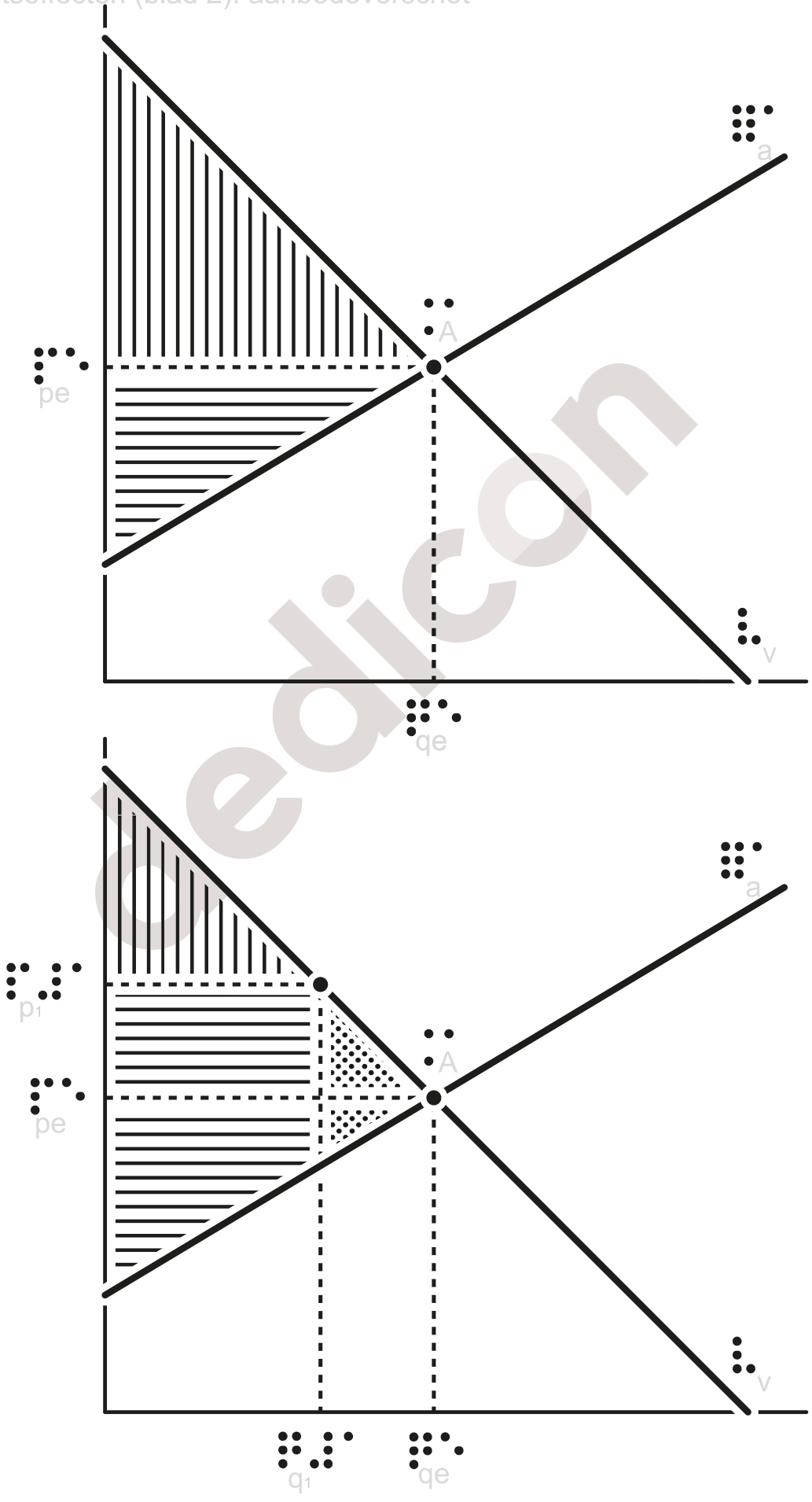

Dit is een inzage-exemplaar. Kopiëren en vermenigvuldigen is niet toegestaan.
Deze tekening komt uit een Op de Tast boek, uitsluitend te bestellen door of voor leerlingen met een visuele beperking op <https://educatief.dedicon.nl>

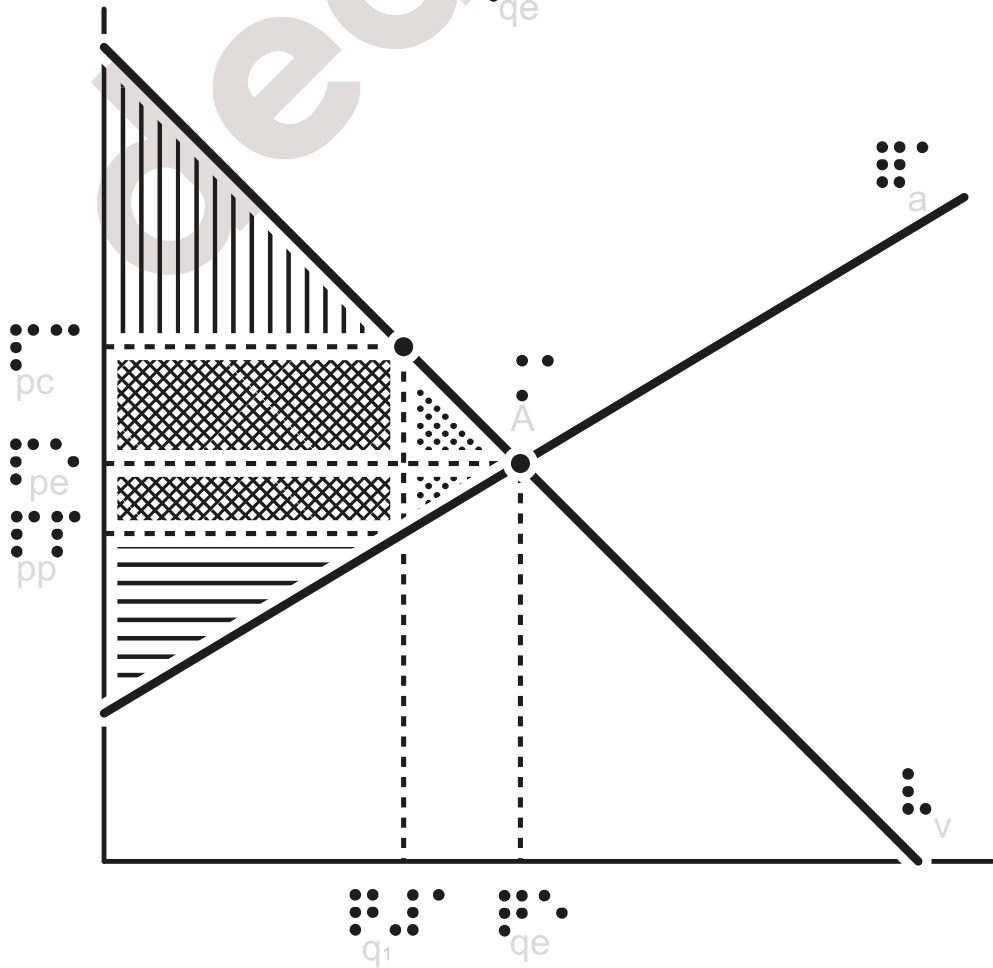
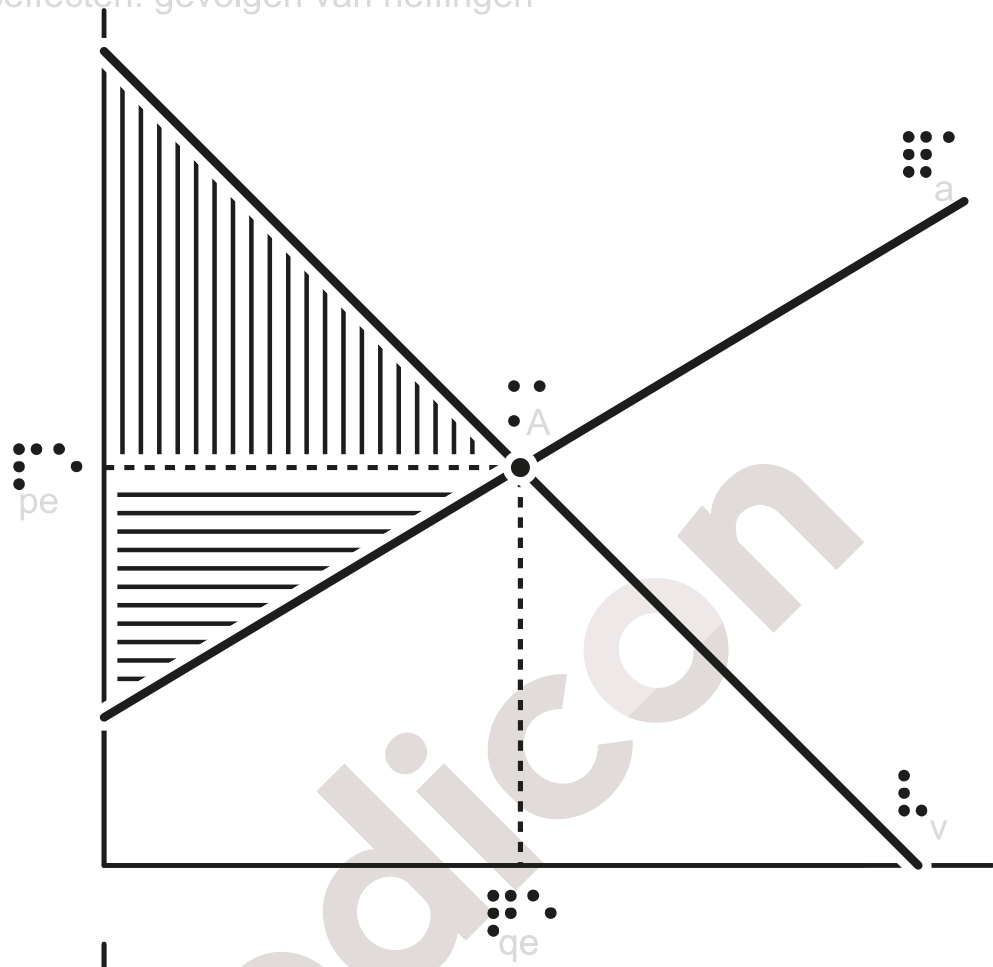

12. Prijselasticiteit

1.

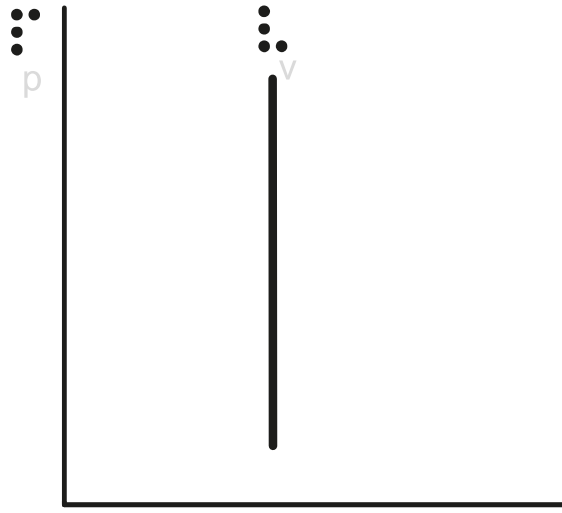

2.

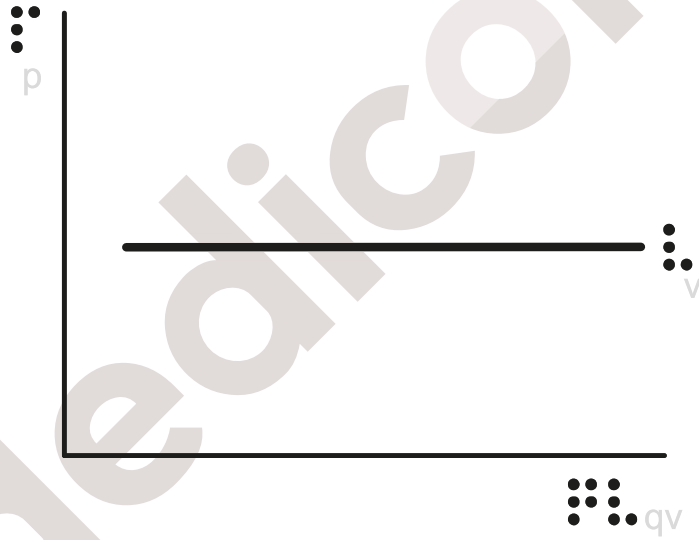

3.

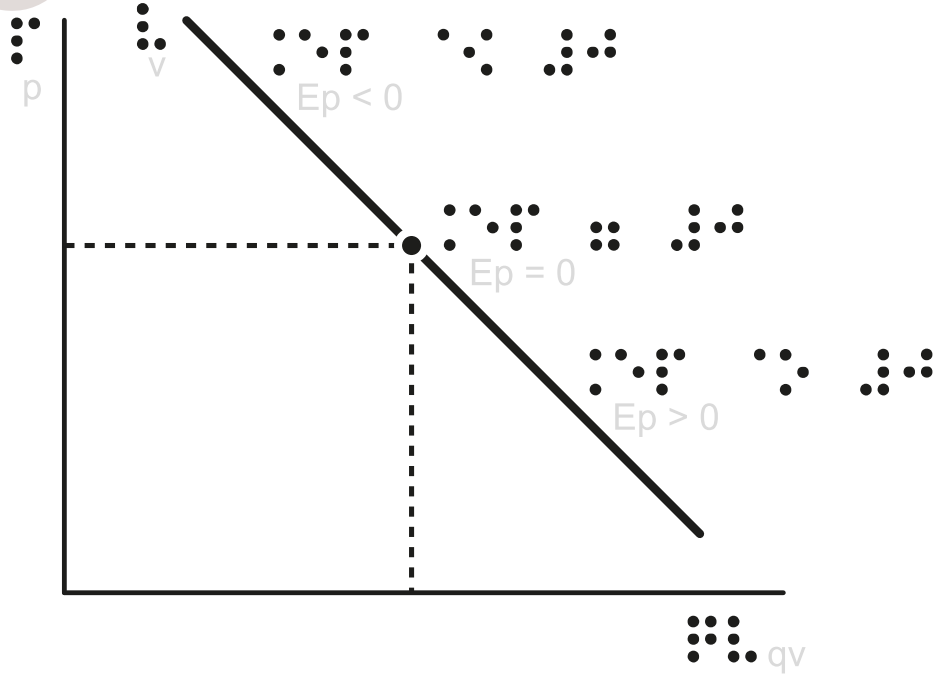

13. Prijselasticiteit van het aanbod

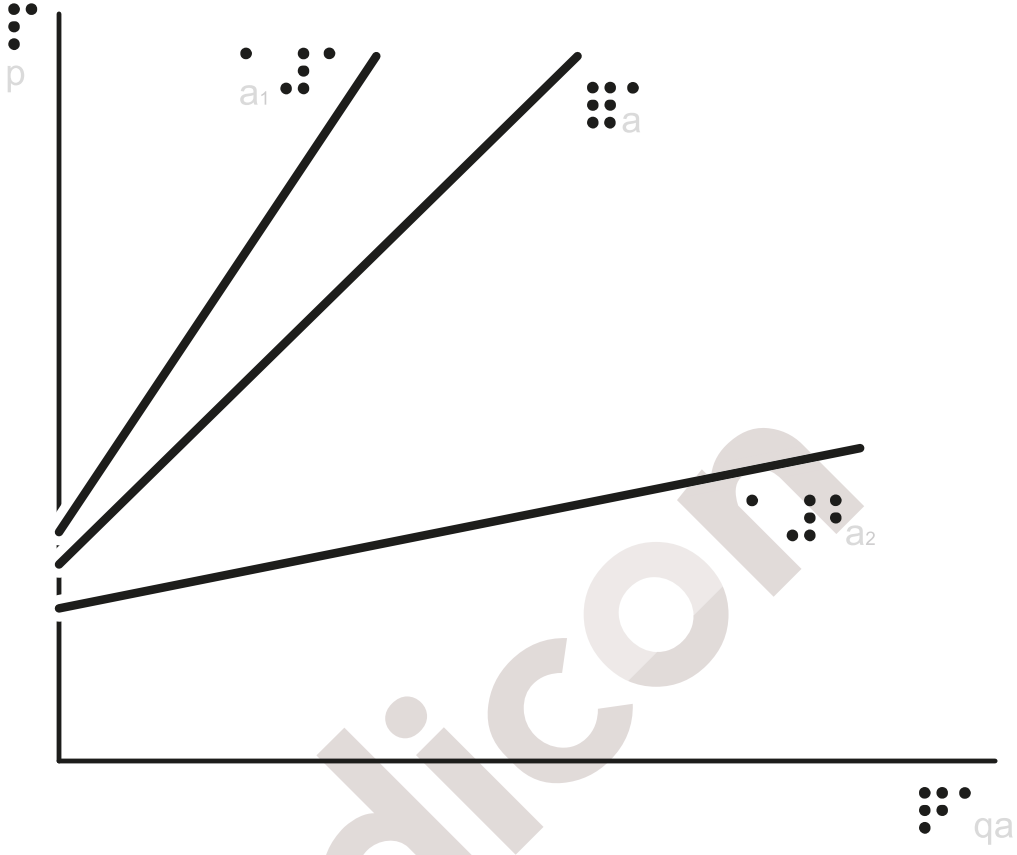

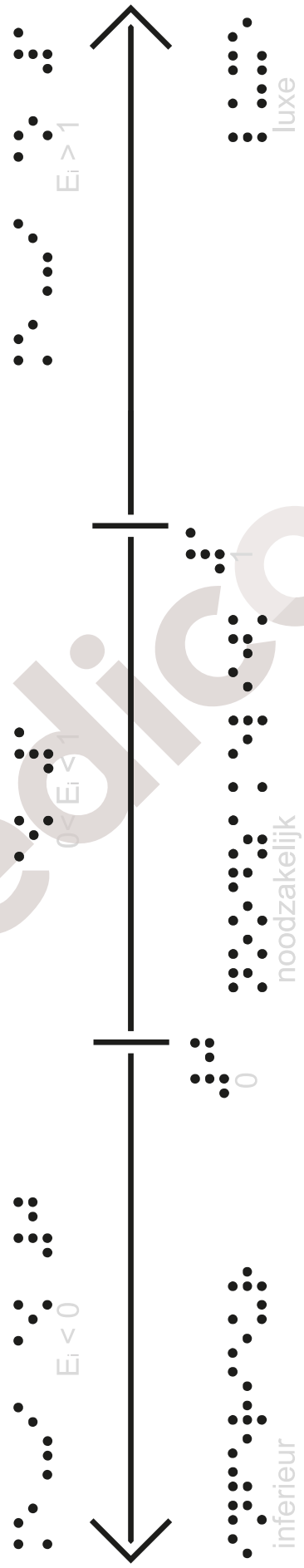
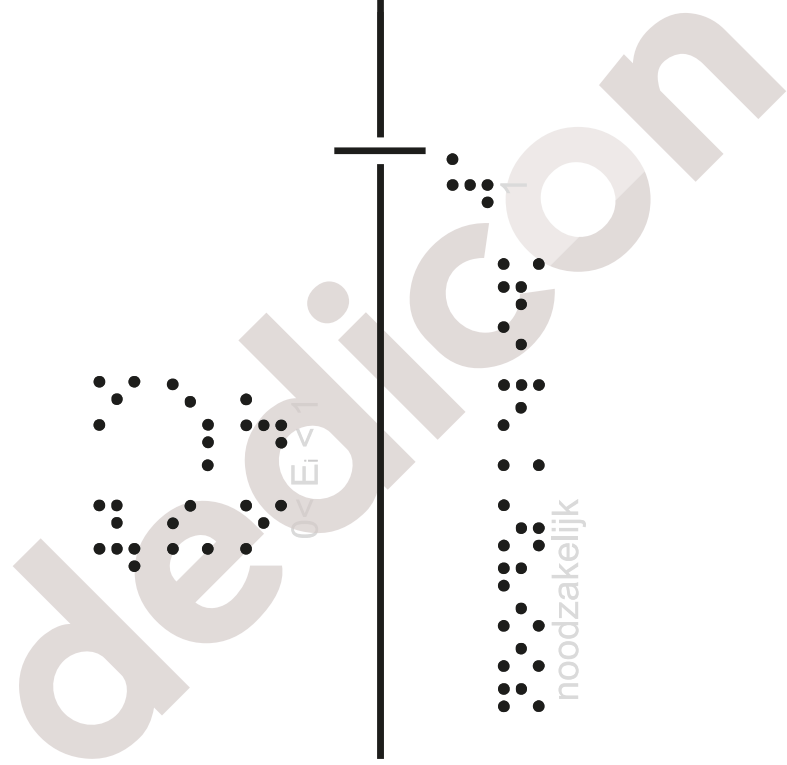



15. Kruiselasticiteit van de vraag



$-\infty$

0

$+\infty$

$E_k = \text{negatief}$

$E_k = 0$

$E_k = \text{positief}$

dedicon



dwars

16. Marktvorm: volledige mededinging (blad 1)

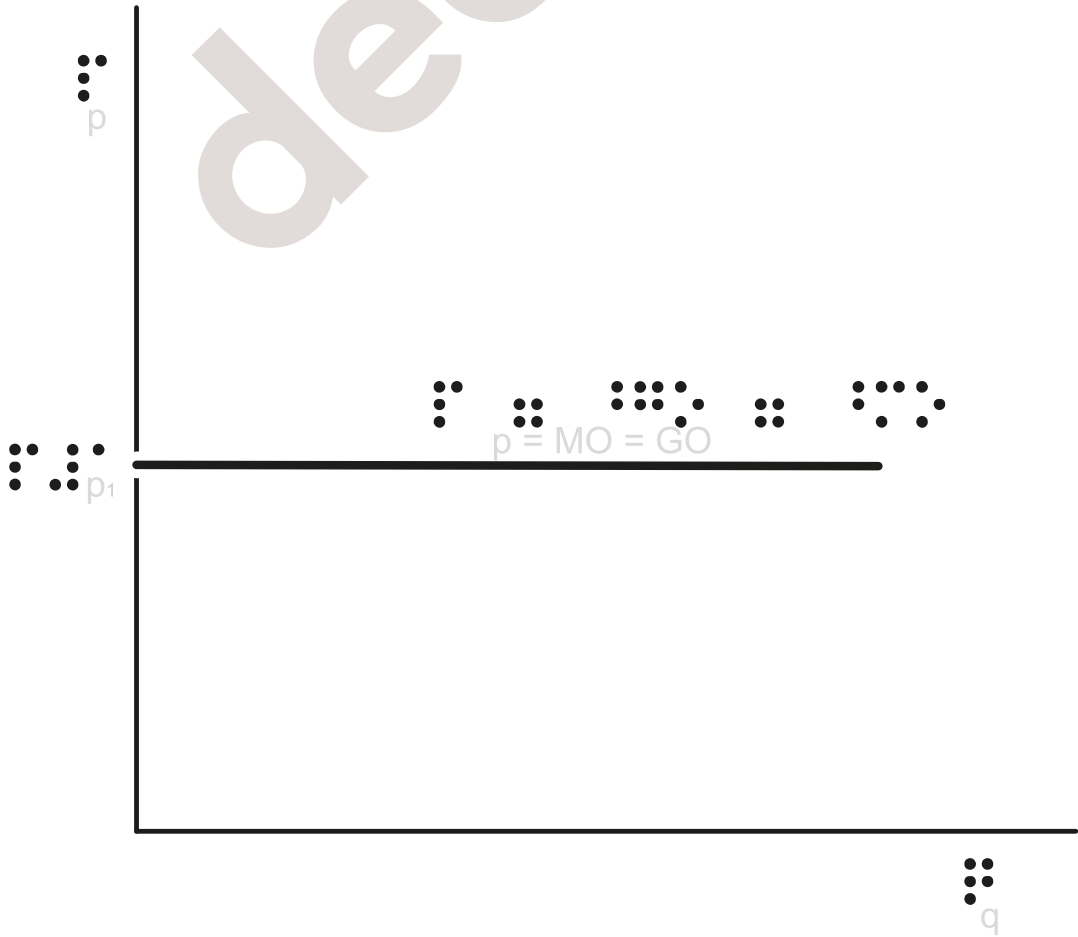
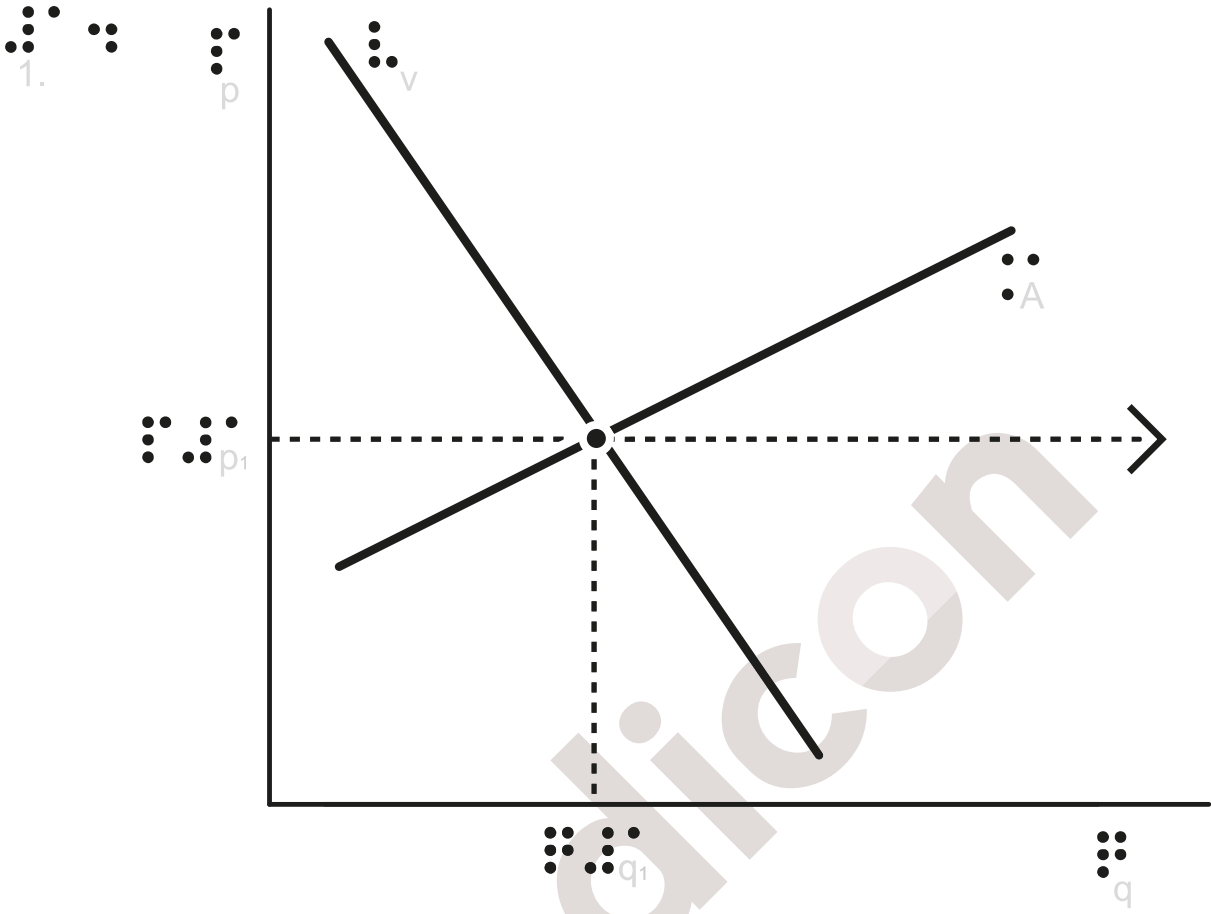

16. Marktvorm: volledige mededinging (blad 2)

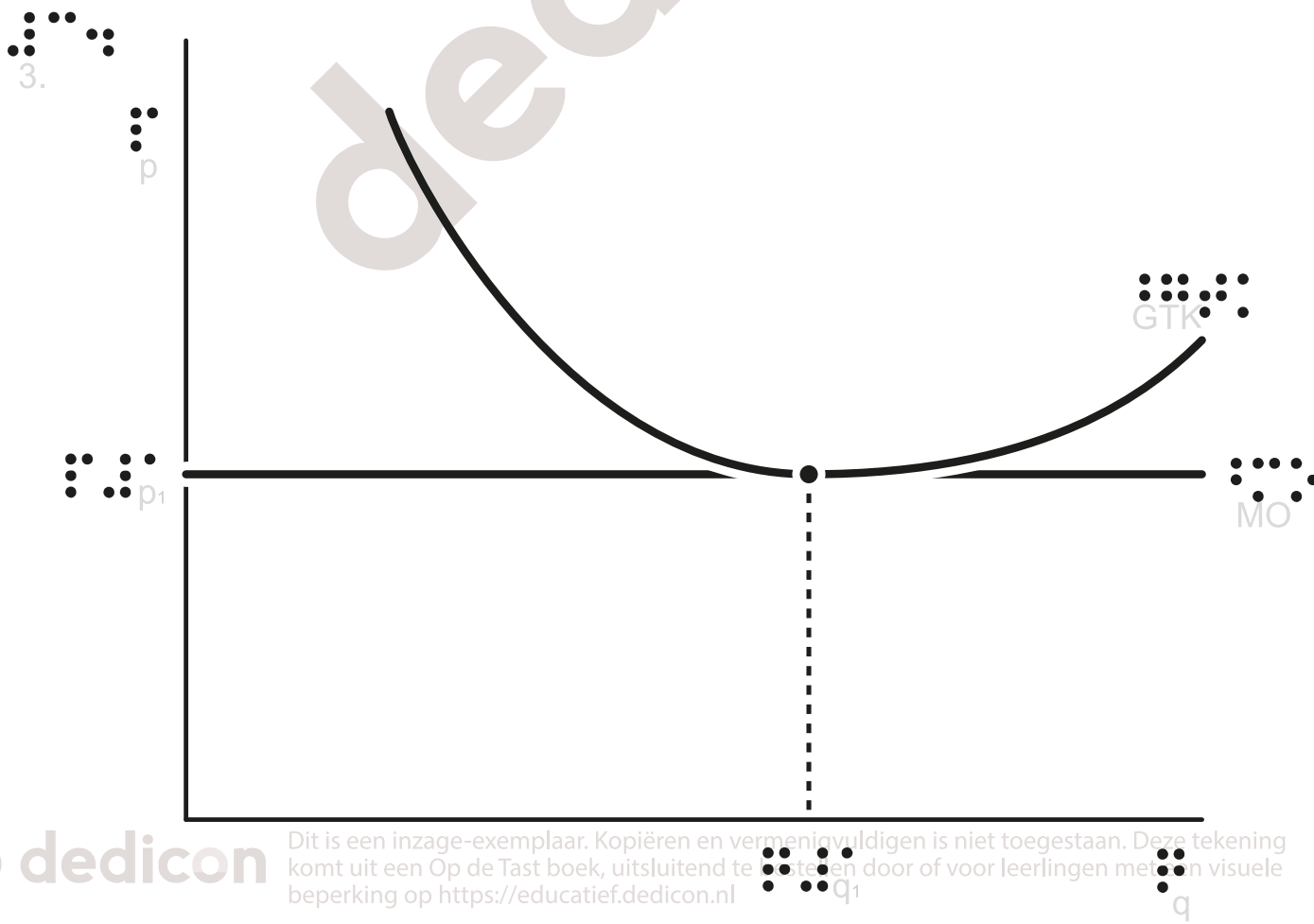
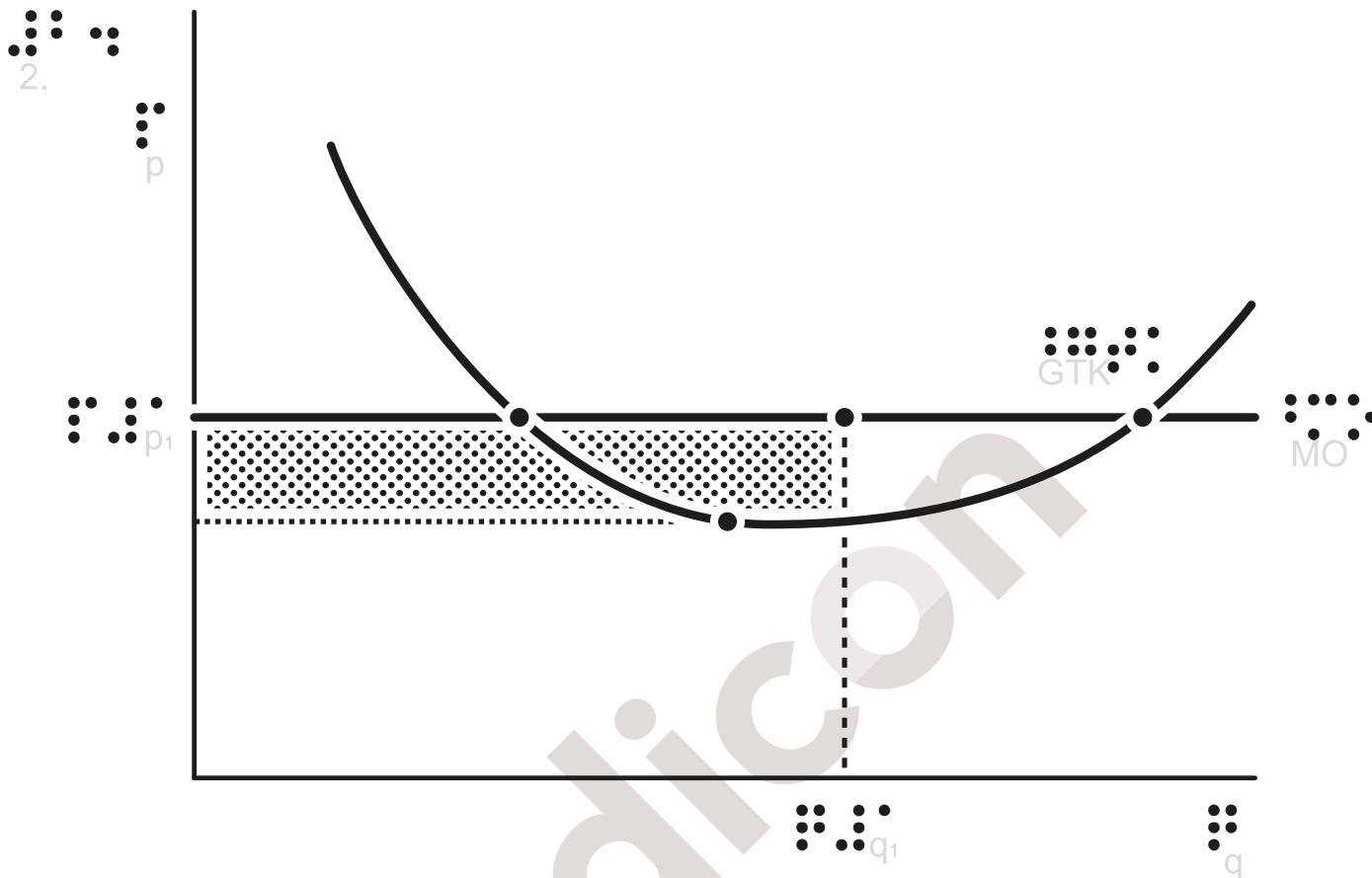

16. Marktvorm: volledige mededinging (blad 3)

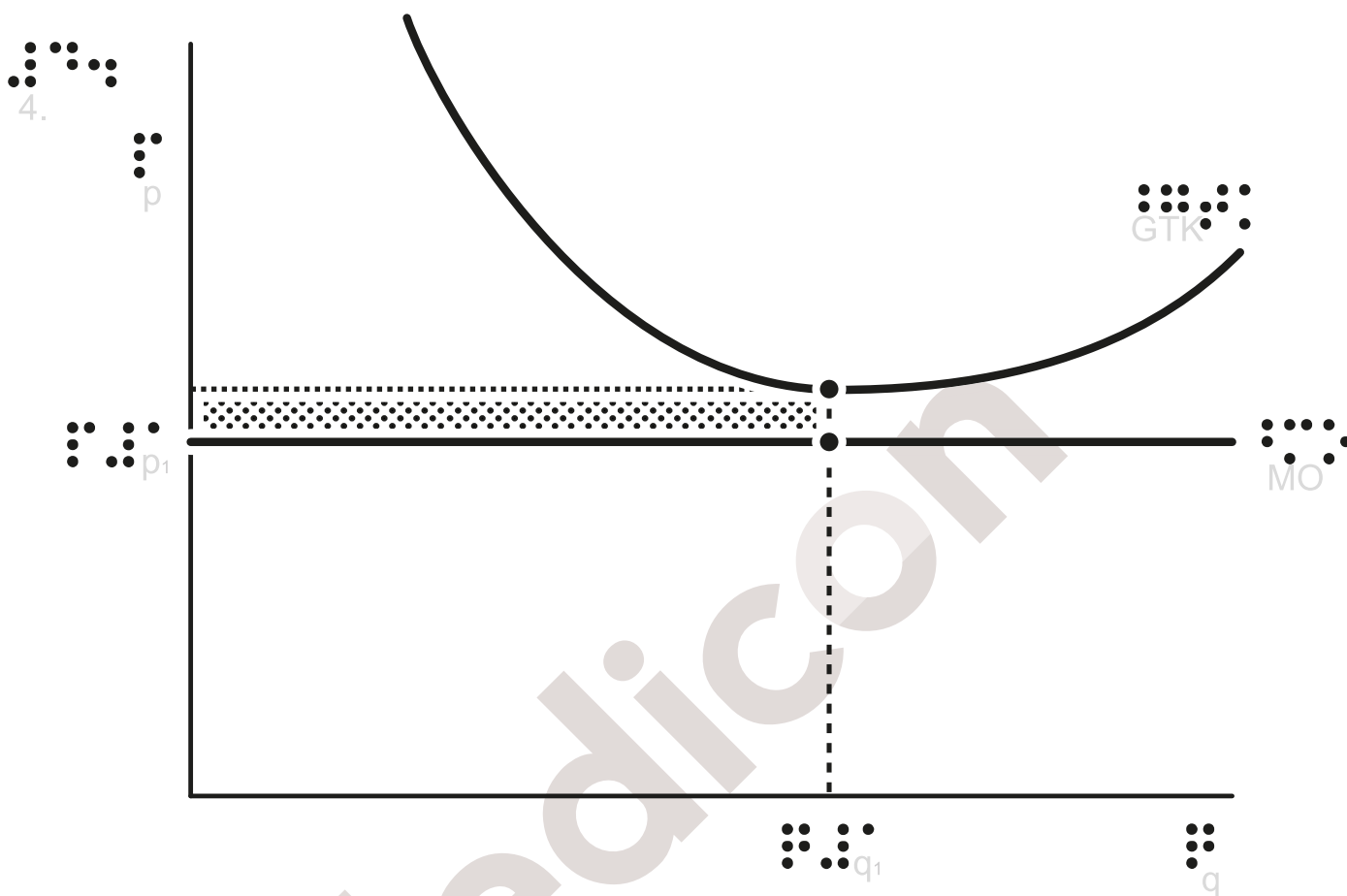

17. Monopolie

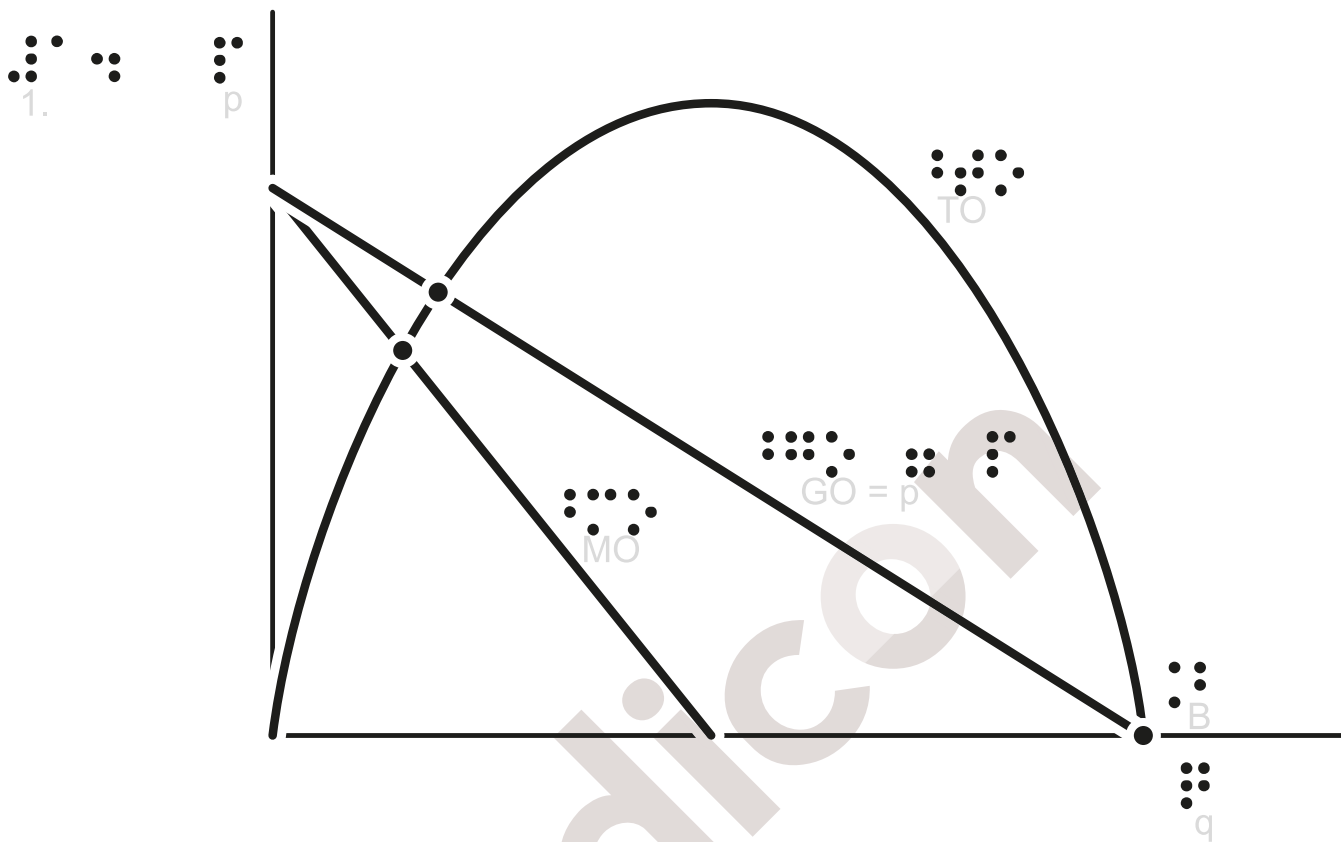

18. Monopolistische concurrentie

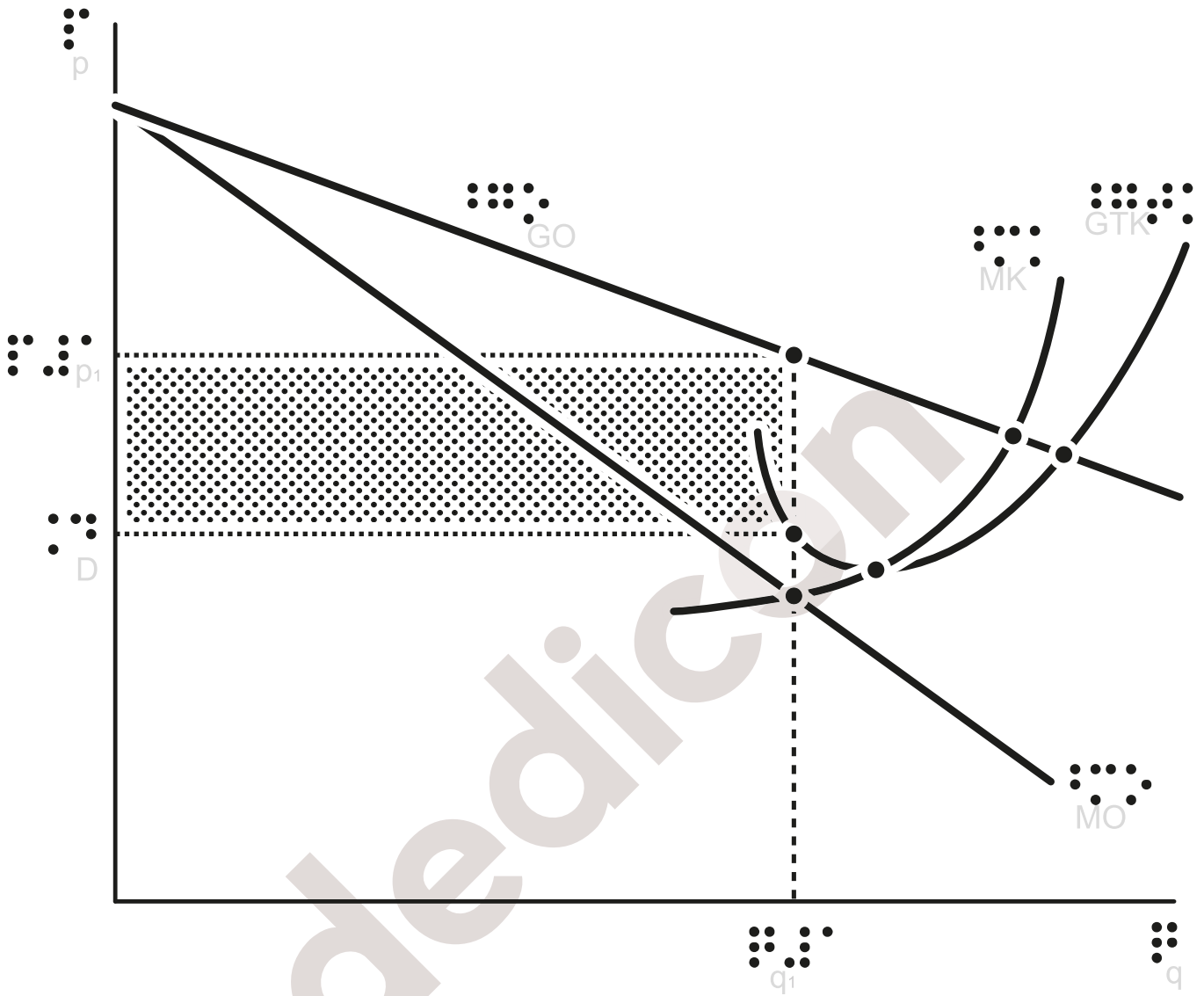

19. Oligopolie

